

Type 10  
Side Ported

Type 11  
Bottom Ported

# Plug-in Connector Connecting Base

D-sub Connector



# 25A-SY5000 Series



## How to Order Manifold

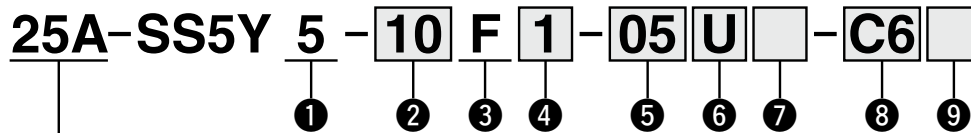

• Series compatible with secondary batteries

### 1 Series

5	SY5000
---	--------

### 2 Type

10	Side ported
11	Bottom ported

### 3 Connector type

F: D-sub connector (25 pins)

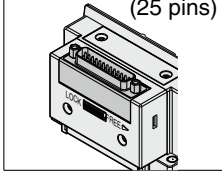

### 4 Connector entry direction

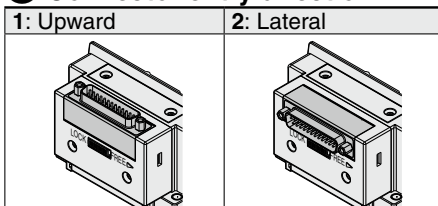

### 5 Valve stations

F: D-sub connector (25 pins)

Symbol	Stations	Note
02	2 stations	Double wiring*1
⋮	⋮	
12	12 stations	
02	2 stations	Specified layout*2 (Available up to 24 solenoids)
⋮	⋮	
24	24 stations	

\*1 Double wiring: 2-position single, double, 3-position, and 4-position valves can be used on all manifold stations. Use of a 2-position single solenoid will result in an unused control signal. If

this is not desired, order with a specified layout.

\*2 Specified layout: Indicate the wiring specifications on the manifold specification sheet. (Note that 2-position double, 3-position, and 4-position valves cannot be used where single wiring has been specified.)

\* This also includes the number of the blanking plate assembly.

### 6 P, E port entry

U	U side (2 to 10 stations)
D	D side (2 to 10 stations)
B	Both sides (2 to 24 stations)

### 7 SUP/EXH block assembly

Nil	Internal pilot
S	Internal pilot, Built-in silencer

\* 3/5(E) port is plugged for the built-in silencer type.

### 8 A, B port size (Metric)

Symbol	A, B port	Type 10/ Side ported	Type 11/ Bottom ported
		SY5000	SY5000
C4	Straight ø4 One-touch fitting	●	●
C6		●	●
C8		●	●
CM*1	Straight port, mixed sizes	●	●
P, E port size (One-touch fittings)		ø10	ø10

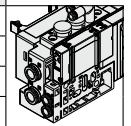

\*1 Indicate the sizes on the manifold specification sheet in the case of "CM."

\* The direction of P, E port fittings is the same as for the A, B port.

### 9 Mounting

Symbol	Mounting
Nil	Direct mounting
D□	DIN rail mounting

#### DIN rail option

Nil	Standard length	
0	With DIN bracket (Without DIN rail)	
3	For 3 stations	Specify a longer rail than the total length of specified stations.
⋮	⋮	
24	For 24 stations	

\* Enter the number of stations inside □. (Refer to "DIN Rail Option" above.)

\* Only direct mounting is available for Type 11 (Bottom ported).

\* The 25A- series specifications and dimensions are the same as those of the standard model.

[Click here for details.](#)

**How to Order Valves (With two mounting screws)**

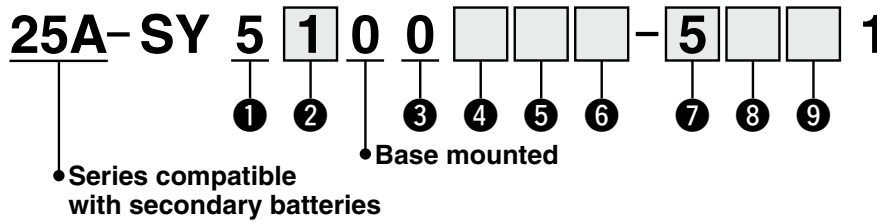

**1 Series**

5	SY5000
---	--------

**2 Type of actuation**

1	2-position single
2	2-position double
3	3-position closed center
4	3-position exhaust center
5	3-position pressure center
A	4-position dual 3-port valve (N.C./N.C.)
B	4-position dual 3-port valve (N.O./N.O.)
C	4-position dual 3-port valve (N.C./N.O.)

**3 Seal type**

0	Rubber seal
---	-------------

**4 Back pressure check valve (Built-in valve type)**

Nil	None
H	Built-in

\* The built-in valve type back pressure check valve is not available for the 3-position type.

**5 Pilot valve option**

Nil	Standard (0.7 MPa)
B	Quick response type (0.7 MPa)

**6 Coil type**

Nil	Standard
T	With power saving circuit (Continuous duty type)

\* Be sure to select the power saving circuit type when the valve is continuously energized for long periods of time.  
 \* Be careful of the energizing time when the power saving circuit is selected. For details, refer to the standard product catalog.

**7 Rated voltage**

5	24 VDC
6	12 VDC

**8 Light/surge voltage suppressor and common specification**

Nil	Without light/surge voltage suppressor (Non-polar)
R	With surge voltage suppressor (Non-polar)
U	With light/surge voltage suppressor (Non-polar)
S	With surge voltage suppressor (Positive common)
Z	With light/surge voltage suppressor (Positive common)
NS	With surge voltage suppressor (Negative common)
NZ	With light/surge voltage suppressor (Negative common)

\* Only "Z" and "NZ" types are available for the product with power saving circuit.

**9 Manual override**

<p><b>Nil:</b> Non-locking push type</p>	<p><b>D:</b> Push-turn locking slotted type</p>
<p><b>E:</b> Push-turn locking lever type</p>	<p><b>F:</b> Slide locking type</p>

\* The 25A- series specifications and dimensions are the same as those of the standard model.

[Click here for details.](#)

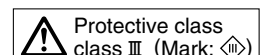

# Plug-in Connector Connecting Base

D-sub Connector



Type 12  
Top Ported

# 25A-SY5000 Series

## How to Order Manifold

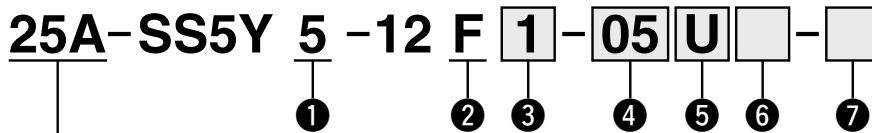

• Series compatible with secondary batteries

### 1 Series

5	SY5000
---	--------

### 2 Connector type

F: D-sub connector (25 pins)

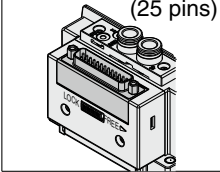

### 3 Connector entry direction

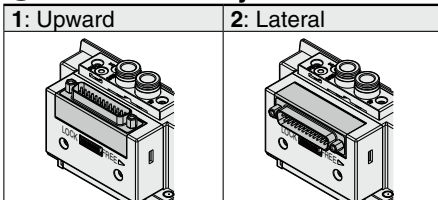

### 4 Valve stations

F: D-sub connector (25 pins)

Symbol	Stations	Note
02	2 stations	Double wiring*1
⋮	⋮	
12	12 stations	Specified layout*2 (Available up to 24 solenoids)
02	2 stations	
⋮	⋮	
24	24 stations	

\*1 Double wiring: 2-position single, double, 3-position, and 4-position valves can be used on all manifold stations. Use of a 2-position single solenoid will result in an unused control signal. If this is not desired, order

with a specified layout.

\*2 Specified layout: Indicate the wiring specifications on the manifold specification sheet. (Note that 2-position double, 3-position, and 4-position valves cannot be used where single wiring has been specified.)

\* This also includes the number of the blanking plate assembly.

### 5 P, E port entry

U*1	U side (2 to 10 stations)
D*1	D side (2 to 10 stations)
B	Both sides (2 to 24 stations)

\*1 \*6 For type "S," supply/exhaust block assembly with built-in silencer, choose "U" or "D" for P port entry.

### 6 SUP/EXH block assembly

Nil	Internal pilot
S	Internal pilot, Built-in silencer

\* For built-in silencer type, P and E ports are available on U and D sides. 3/5(E) port is plugged. The silencer exhaust port is located on the opposite side of P, E port entry. (Example: When the P, E port entry is D side, the silencer exhaust port is U side.)

### 7 Mounting

Nil	Direct mounting	
D	DIN rail mounting (With DIN rail)	
D0	DIN rail mounting (Without DIN rail)	
D3	For 3 stations	Specify a longer rail than the standard length.
⋮	⋮	
D24	For 24 stations	

\* The 25A- series specifications and dimensions are the same as those of the standard model.

[Click here for details.](#)

**How to Order Valves (With two mounting screws)**

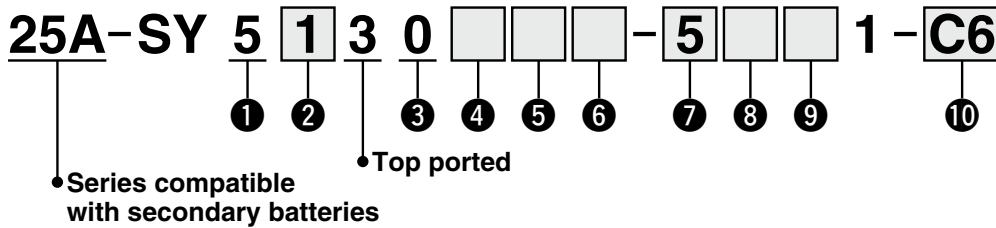

**1 Series**

5	SY5000
---	--------

**2 Type of actuation**

1	2-position single
2	2-position double
3	3-position closed center
4	3-position exhaust center
5	3-position pressure center
A	4-position dual 3-port valve (N.C./N.C.)
B	4-position dual 3-port valve (N.O./N.O.)
C	4-position dual 3-port valve (N.C./N.O.)

**3 Seal type**

0	Rubber seal
---	-------------

**4 Back pressure check valve (Built-in valve type)**

Nil	None
H	Built-in

\* The built-in valve type back pressure check valve is not available for the 3-position type.

**5 Pilot valve option**

Nil	Standard (0.7 MPa)
B	Quick response type (0.7 MPa)

**6 Coil type**

Nil	Standard
T	With power saving circuit (Continuous duty type)

\* Be sure to select the power saving circuit type when the valve is continuously energized for long periods of time.  
 \* Be careful of the energizing time when the power saving circuit is selected. For details, refer to the standard product catalog.

**7 Rated voltage**

5	24 VDC
6	12 VDC

**8 Light/surge voltage suppressor and common specification**

Nil	Without light/surge voltage suppressor (Non-polar)
R	With surge voltage suppressor (Non-polar)
U	With light/surge voltage suppressor (Non-polar)
S	With surge voltage suppressor (Positive common)
Z	With light/surge voltage suppressor (Positive common)
NS	With surge voltage suppressor (Negative common)
NZ	With light/surge voltage suppressor (Negative common)

\* Only "Z" and "NZ" types are available for the product with power saving circuit.

**9 Manual override**

<p><b>Nil:</b> Non-locking push type</p>	<p><b>D:</b> Push-turn locking slotted type</p>
<p><b>E:</b> Push-turn locking lever type</p>	<p><b>F:</b> Slide locking type</p>

**10 A, B port size**

**One-touch fitting (Metric)**

Symbol	A, B port	SY5000
C4	ø4 One-touch fitting	●
C6	ø6 One-touch fitting	●
C8	ø8 One-touch fitting	●

\* The 25A- series specifications and dimensions are the same as those of the standard model.

[Click here for details.](#)

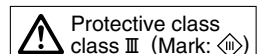

Type 10  
Side Ported

Type 11  
Bottom Ported

# Plug-in Connector Connecting Base

Terminal Block Box



# 25A-SY5000 Series



## How to Order Manifold

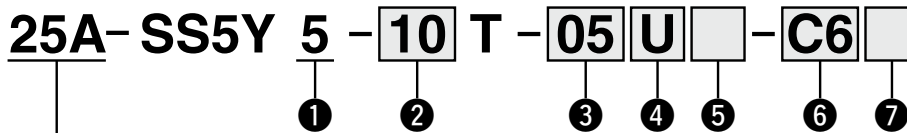

• Series compatible with secondary batteries

### 1 Series

5	SY5000
---	--------

### 2 Type

10	Side ported
11	Bottom ported

### 3 Valve stations

Symbol	Stations	Note
02	2 stations	Double wiring*1
⋮	⋮	
10	10 stations	Specified layout*2 (Available up to 20 solenoids)
02	2 stations	
⋮	⋮	
20	20 stations	

\*1 Double wiring: 2-position single, double, 3-position, and 4-position valves can be used on all manifold stations.

Use of a 2-position single solenoid will result in an unused control signal. If this is not desired, order with a specified layout.

\*2 Specified layout: Indicate the wiring specifications on the manifold specification sheet. (Note that 2-position double, 3-position, and 4-position valves cannot be used where single wiring has been specified.)

\* This also includes the number of the blanking plate assembly.

### 4 P, E port entry

U	U side (2 to 10 stations)
D	D side (2 to 10 stations)
B	Both sides (2 to 20 stations)

### 5 SUP/EXH block assembly

Nil	Internal pilot
S	Internal pilot, Built-in silencer

\* 3/5(E) port is plugged for the built-in silencer type.

\* When the built-in silencer type is used, keep the exhaust port from coming in direct contact with water or other liquids.

### 7 Mounting

Symbol	Mounting
Nil	Direct mounting
D□	DIN rail mounting

\* Enter the number of stations inside □. (Refer to "DIN Rail Option" below.)

\* Only direct mounting is available for Type 11 (Bottom ported).

### DIN rail option

Nil	Standard length
0	With DIN bracket (Without DIN rail)
3	For 3 stations
⋮	⋮
24	For 24 stations

Specify a longer rail than the total length of specified stations.

### 6 A, B port size (Metric)

Symbol	A, B port	Type 10/ Side ported	Type 11/ Bottom ported
		SY5000	SY5000
C4	Straight	●	●
C6		●	●
C8		●	●
CM*1		●	●
P, E port size (One-touch fittings)		ø10	ø10

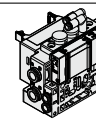

\*1 Indicate the sizes on the manifold specification sheet in the case of "CM."

\* The direction of P, E port fittings is the same as for the A, B port.

\* The 25A- series specifications and dimensions are the same as those of the standard model.

[Click here for details.](#)

### How to Order Valves (With two mounting screws)

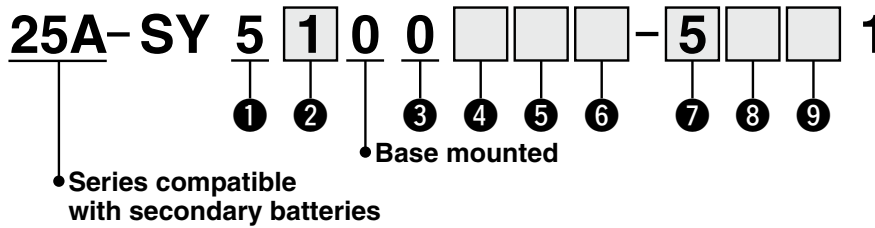

#### 1 Series

5	SY5000
---	--------

#### 2 Type of actuation

1	2-position single
2	2-position double
3	3-position closed center
4	3-position exhaust center
5	3-position pressure center
A	4-position dual 3-port valve (N.C./N.C.)
B	4-position dual 3-port valve (N.O./N.O.)
C	4-position dual 3-port valve (N.C./N.O.)

#### 3 Seal type

0	Rubber seal
---	-------------

#### 4 Back pressure check valve (Built-in valve type)

Nil	None
H	Built-in

\* The built-in valve type back pressure check valve is not available for the 3-position type.

#### 5 Pilot valve option

Nil	Standard (0.7 MPa)
B	Quick response type (0.7 MPa)

#### 6 Coil type

Nil	Standard
T	With power saving circuit (Continuous duty type)

\* Be sure to select the power saving circuit type when the valve is continuously energized for long periods of time.  
\* Be careful of the energizing time when the power saving circuit is selected. For details, refer to the standard product catalog.

#### 7 Rated voltage

5	24 VDC
6	12 VDC

#### 8 Light/surge voltage suppressor and common specification

Nil	Without light/surge voltage suppressor (Non-polar)
R	With surge voltage suppressor (Non-polar)
U	With light/surge voltage suppressor (Non-polar)
S	With surge voltage suppressor (Positive common)
Z	With light/surge voltage suppressor (Positive common)
NS	With surge voltage suppressor (Negative common)
NZ	With light/surge voltage suppressor (Negative common)

\* Only "Z" and "NZ" types are available for the product with power saving circuit.

#### 9 Manual override

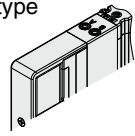
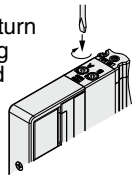
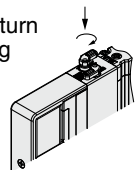
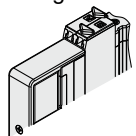
<b>Nil:</b> Non-locking push type 	<b>D:</b> Push-turn locking slotted type 
<b>E:</b> Push-turn locking lever type 	<b>F:</b> Slide locking type 

\* The 25A- series specifications and dimensions are the same as those of the standard model.

[Click here for details.](#)

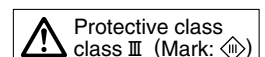

# Plug-in Connector Connecting Base

Terminal Block Box



Type 12  
Top Ported

# 25A-SY5000 Series

## How to Order Manifold

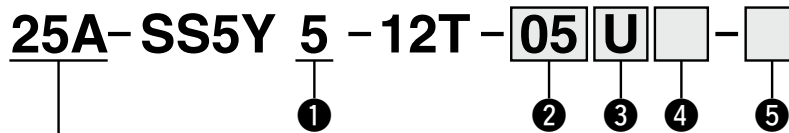

• Series compatible with secondary batteries

### 1 Series

5	SY5000
---	--------

### 3 P, E port entry

U*1	U side (2 to 10 stations)
D*1	D side (2 to 10 stations)
B	Both sides (2 to 20 stations)

\*1 4 For type "S," supply/exhaust block assembly with built-in silencer, choose "U" or "D" for P port entry.

### 2 Valve stations

Symbol	Stations	Note
02	2 stations	Double wiring*1
⋮	⋮	
10	10 stations	
02	2 stations	Specified layout*2 (Available up to 20 solenoids)
⋮	⋮	
20	20 stations	

\*1 Double wiring: 2-position single, double, 3-position, and 4-position valves can be used on all manifold stations. Use of a 2-position single solenoid will result in an unused control signal. If this is not desired, order with a specified layout.

\*2 Specified layout: Indicate the wiring specifications on the manifold specification sheet. (Note that 2-position double, 3-position, and 4-position valves cannot be used where single wiring has been specified.)

\* This also includes the number of the blanking plate assembly.

### 4 SUP/EXH block assembly

Nil	Internal pilot
S	Internal pilot, Built-in silencer

\* For built-in silencer type, P and E ports are available on U and D sides. 3/5(E) port is plugged. The silencer exhaust port is located on the opposite side of P, E port entry.

(Example: When the P, E port entry is D side, the silencer exhaust port is U side.)

\* When the built-in silencer type is used, keep the exhaust port from coming in direct contact with water or other liquids.

### 5 Mounting

Nil	Direct mounting	
D	DIN rail mounting (With DIN rail)	
D0	DIN rail mounting (Without DIN rail)	
D3	For 3 stations	Specify a longer rail than the standard length.
⋮	⋮	
D20	For 20 stations	

\* The 25A- series specifications and dimensions are the same as those of the standard model.

[Click here for details.](#)

**How to Order Valves (With two mounting screws)**

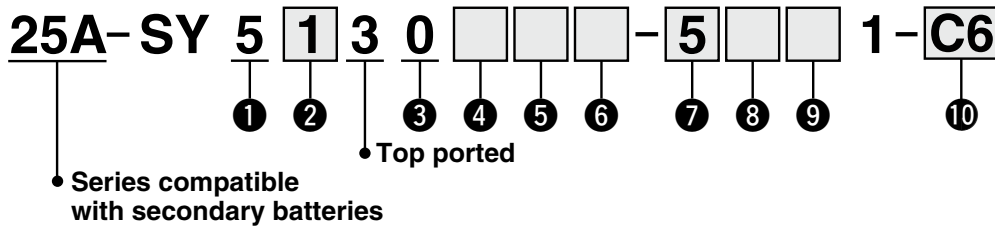

**1 Series**

5	SY5000
---	--------

**2 Type of actuation**

1	2-position single
2	2-position double
3	3-position closed center
4	3-position exhaust center
5	3-position pressure center
A	4-position dual 3-port valve (N.C./N.C.)
B	4-position dual 3-port valve (N.O./N.O.)
C	4-position dual 3-port valve (N.C./N.O.)

**3 Seal type**

0	Rubber seal
---	-------------

**4 Back pressure check valve (Built-in valve type)**

Nil	None
H	Built-in

\* The built-in valve type back pressure check valve is not available for the 3-position type.

**5 Pilot valve option**

Nil	Standard (0.7 MPa)
B	Quick response type (0.7 MPa)

**6 Coil type**

Nil	Standard
T	With power saving circuit (Continuous duty type)

\* Be sure to select the power saving circuit type when the valve is continuously energized for long periods of time.  
\* Be careful of the energizing time when the power saving circuit is selected. For details, refer to the standard product catalog.

**7 Rated voltage**

5	24 VDC
6	12 VDC

**8 Light/surge voltage suppressor and common specification**

Nil	Without light/surge voltage suppressor (Non-polar)
R	With surge voltage suppressor (Non-polar)
U	With light/surge voltage suppressor (Non-polar)
S	With surge voltage suppressor (Positive common)
Z	With light/surge voltage suppressor (Positive common)
NS	With surge voltage suppressor (Negative common)
NZ	With light/surge voltage suppressor (Negative common)

\* Only "Z" and "NZ" types are available for the product with power saving circuit.

**9 Manual override**

<p><b>Nil:</b> Non-locking push type</p>	<p><b>D:</b> Push-turn locking slotted type</p>
<p><b>E:</b> Push-turn locking lever type</p>	<p><b>F:</b> Slide locking type</p>

**10 A, B port size One-touch fitting (Metric)**

Symbol	A, B port	SY5000
C4	ø4 One-touch fitting	●
C6	ø6 One-touch fitting	●
C8	ø8 One-touch fitting	●

\* The 25A- series specifications and dimensions are the same as those of the standard model.

[Click here for details.](#)

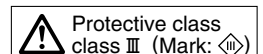

Type 10  
Side Ported

Type 11  
Bottom Ported

# Plug-in Connector Connecting Base

Lead Wire



# 25A-SY5000 Series



## How to Order Manifold

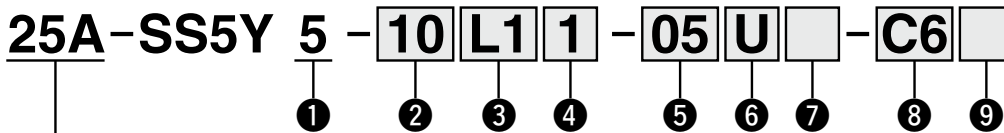

• Series compatible with secondary batteries

### 1 Series

5	SY5000
---	--------

### 3 Number of cores (Lead wire)

L1	34 cores
L2	17 cores
L3	9 cores

### 6 P, E port entry

U	U side (2 to 10 stations)
D	D side (2 to 10 stations)
B	Both sides (2 to 24 stations)

### 2 Type

10	Side ported
11	Bottom ported

### 4 Lead wire length

1	0.6 m
2	1.5 m
3	3 m

### 7 SUP/EXH block assembly

Nil	Internal pilot
S	Internal pilot, Built-in silencer

\* 3/5(E) port is plugged for the built-in silencer type.

\* When the built-in silencer type is used, keep the exhaust port from coming in direct contact with water or other liquids.

### 5 Valve stations

(L1□)

Symbol	Stations	Note
02	2 stations	Double wiring*1
⋮	⋮	
16	16 stations	Specified layout*2 (Available up to 32 solenoids)
02	2 stations	
⋮	⋮	
24	24 stations	

(L3□)

Symbol	Stations	Note
02	2 stations	Double wiring*1
⋮	⋮	
04	4 stations	Specified layout*2 (Available up to 8 solenoids)
02	2 stations	
⋮	⋮	
08	8 stations	

(L2□)

Symbol	Stations	Note
02	2 stations	Double wiring*1
⋮	⋮	
08	8 stations	Specified layout*2 (Available up to 16 solenoids)
02	2 stations	
⋮	⋮	
16	16 stations	

\*1 Double wiring: 2-position single, double, 3-position, and 4-position valves can be used on all manifold stations. Use of a 2-position single solenoid will result in an unused control signal. If this is not desired, order with a specified layout.

\*2 Specified layout: Indicate the wiring specifications on the manifold specification sheet. (Note that 2-position double, 3-position, and 4-position valves cannot be used where single wiring has been specified.)

\* This also includes the number of the blanking plate assembly.

### 8 A, B port size (Metric)

Symbol	A, B port	Type 10/ Side ported	Type 11/ Bottom ported
		SY5000	SY5000
C4	Straight ø4 One-touch fitting	●	●
C6		●	●
C8		●	●
CM*1	Straight port, mixed sizes	●	●
P, E port size (One-touch fittings)		ø10	ø10

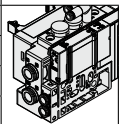

\*1 Indicate the sizes on the manifold specification sheet in the case of "CM."

\* The direction of P, E port fittings is the same as for the A, B port.

### 9 Mounting

Symbol	Mounting
Nil	Direct mounting
D□	DIN rail mounting

\* Enter the number of stations inside □. (Refer to "DIN Rail Option" below.)

\* Only direct mounting is available for Type 11 (Bottom ported).

#### DIN rail option

Nil	Standard length	
0	With DIN bracket (Without DIN rail)	
3	For 3 stations	Specify a longer rail than the total length of specified stations.
⋮	⋮	
24	For 24 stations	

\* The 25A- series specifications and dimensions are the same as those of the standard model.

[Click here for details.](#)

**How to Order Valves (With two mounting screws)**

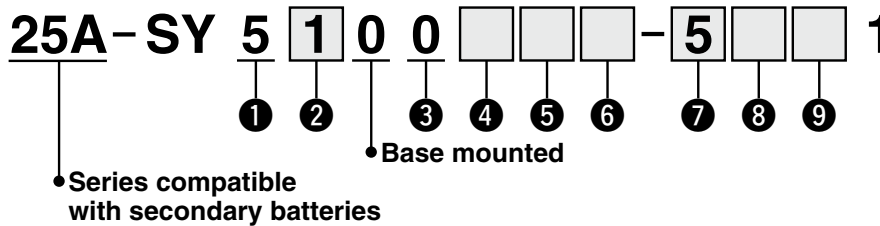

**1 Series**

5	SY5000
---	--------

**2 Type of actuation**

1	2-position single
2	2-position double
3	3-position closed center
4	3-position exhaust center
5	3-position pressure center
A	4-position dual 3-port valve (N.C./N.C.)
B	4-position dual 3-port valve (N.O./N.O.)
C	4-position dual 3-port valve (N.C./N.O.)

**3 Seal type**

0	Rubber seal
---	-------------

**4 Back pressure check valve (Built-in valve type)**

Nil	None
H	Built-in

\* The built-in valve type back pressure check valve is not available for the 3-position type.

**5 Pilot valve option**

Nil	Standard (0.7 MPa)
B	Quick response type (0.7 MPa)

**6 Coil type**

Nil	Standard
T	With power saving circuit (Continuous duty type)

\* Be sure to select the power saving circuit type when the valve is continuously energized for long periods of time.  
\* Be careful of the energizing time when the power saving circuit is selected. For details, refer to the standard product catalog.

**7 Rated voltage**

5	24 VDC
6	12 VDC

**8 Light/surge voltage suppressor and common specification**

Nil	Without light/surge voltage suppressor (Non-polar)
R	With surge voltage suppressor (Non-polar)
U	With light/surge voltage suppressor (Non-polar)
S	With surge voltage suppressor (Positive common)
Z	With light/surge voltage suppressor (Positive common)
NS	With surge voltage suppressor (Negative common)
NZ	With light/surge voltage suppressor (Negative common)

\* Only "Z" and "NZ" types are available for the product with power saving circuit.

**9 Manual override**

<p><b>Nil:</b> Non-locking push type</p>	<p><b>D:</b> Push-turn locking slotted type</p>
<p><b>E:</b> Push-turn locking lever type</p>	<p><b>F:</b> Slide locking type</p>

\* The 25A- series specifications and dimensions are the same as those of the standard model.

[Click here for details.](#)

# Plug-in Connector Connecting Base

Lead Wire



Type 12  
Top Ported

# 25A-SY5000 Series

## How to Order Manifold

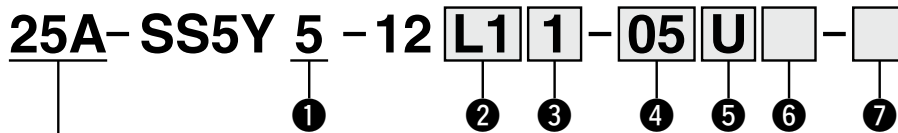

• Series compatible with secondary batteries

### 1 Series

5	SY5000
---	--------

### 2 Number of cores (Lead wire)

L1	34 cores
L2	17 cores
L3	9 cores

### 3 Lead wire length

1	0.6 m
2	1.5 m
3	3 m

### 4 Valve stations

#### (L1□)

Symbol	Stations	Note
02	2 stations	Double wiring*1
⋮	⋮	
16	16 stations	Specified layout*2 (Available up to 32 solenoids)
02	2 stations	
⋮	⋮	
24	24 stations	

#### (L3□)

Symbol	Stations	Note
02	2 stations	Double wiring*1
⋮	⋮	
04	4 stations	Specified layout*2 (Available up to 8 solenoids)
02	2 stations	
⋮	⋮	
08	8 stations	

#### (L2□)

Symbol	Stations	Note
02	2 stations	Double wiring*1
⋮	⋮	
08	8 stations	Specified layout*2 (Available up to 16 solenoids)
02	2 stations	
⋮	⋮	
16	16 stations	

- \*1 Double wiring: 2-position single, double, 3-position, and 4-position valves can be used on all manifold stations. Use of a 2-position single solenoid will result in an unused control signal. If this is not desired, order with a specified layout.
- \*2 Specified layout: Indicate the wiring specifications on the manifold specification sheet. (Note that 2-position double, 3-position, and 4-position valves cannot be used where single wiring has been specified.)
- \* This also includes the number of the blanking plate assembly.

### 5 P, E port entry

U*1	U side (2 to 10 stations)
D*1	D side (2 to 10 stations)
B	Both sides (2 to 24 stations)

\*1 6 For type "S," supply/exhaust block assembly with built-in silencer, choose "U" or "D" for P port entry.

### 6 SUP/EXH block assembly

Nil	Internal pilot
S	Internal pilot, Built-in silencer

- \* For built-in silencer type, P and E ports are available on U and D sides. 3/5(E) port is plugged. The silencer exhaust port is located on the opposite side of P, E port entry. (Example: When the P, E port entry is D side, the silencer exhaust port is U side.)
- \* When the built-in silencer type is used, keep the exhaust port from coming in direct contact with water or other liquids.

### 7 Mounting

Nil	Direct mounting	
D	DIN rail mounting (With DIN rail)	
D0	DIN rail mounting (Without DIN rail)	
D3	For 3 stations	Specify a longer rail than the standard length.
⋮	⋮	
D24	For 24 stations	

\* The 25A- series specifications and dimensions are the same as those of the standard model.

[Click here for details.](#)

**How to Order Valves (With two mounting screws)**

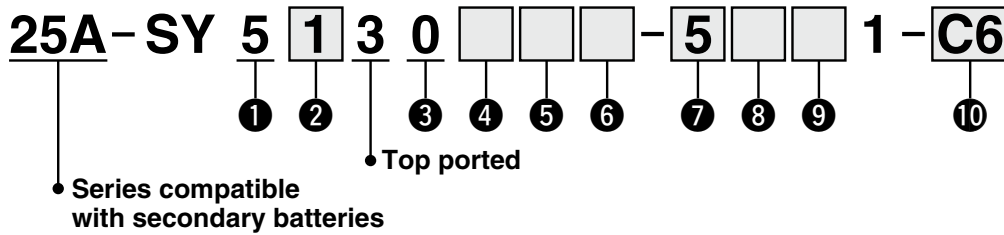

**1 Series**

5	SY5000
---	--------

**2 Type of actuation**

1	2-position single
2	2-position double
3	3-position closed center
4	3-position exhaust center
5	3-position pressure center
A	4-position dual 3-port valve (N.C./N.C.)
B	4-position dual 3-port valve (N.O./N.O.)
C	4-position dual 3-port valve (N.C./N.O.)

**3 Seal type**

0	Rubber seal
---	-------------

**4 Back pressure check valve (Built-in valve type)**

Nil	None
H	Built-in

\* The built-in valve type back pressure check valve is not available for the 3-position type.

**5 Pilot valve option**

Nil	Standard (0.7 MPa)
B	Quick response type (0.7 MPa)

**6 Coil type**

Nil	Standard
T	With power saving circuit (Continuous duty type)

\* Be sure to select the power saving circuit type when the valve is continuously energized for long periods of time.  
 \* Be careful of the energizing time when the power saving circuit is selected. For details, refer to the standard product catalog.

**7 Rated voltage**

5	24 VDC
6	12 VDC

**8 Light/surge voltage suppressor and common specification**

Nil	Without light/surge voltage suppressor (Non-polar)
R	With surge voltage suppressor (Non-polar)
U	With light/surge voltage suppressor (Non-polar)
S	With surge voltage suppressor (Positive common)
Z	With light/surge voltage suppressor (Positive common)
NS	With surge voltage suppressor (Negative common)
NZ	With light/surge voltage suppressor (Negative common)

\* Only "Z" and "NZ" types are available for the product with power saving circuit.

**9 Manual override**

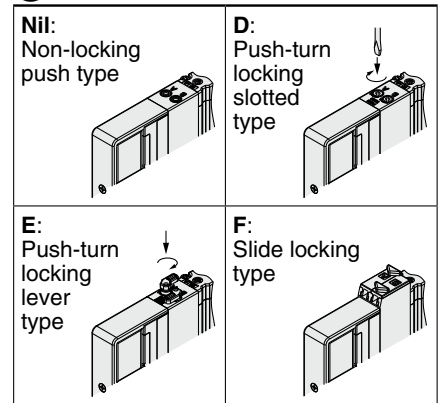

**10 A, B port size One-touch fitting (Metric)**

Symbol	A, B port	SY5000
C4	ø4 One-touch fitting	●
C6	ø6 One-touch fitting	●
C8	ø8 One-touch fitting	●

\* The 25A- series specifications and dimensions are the same as those of the standard model.

[Click here for details.](#)

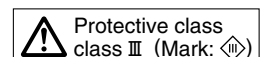

Type 10  
Side Ported

Type 11  
Bottom Ported

# Plug-in Connector Connecting Base

EX260



# 25A-SY5000 Series



## How to Order Manifold

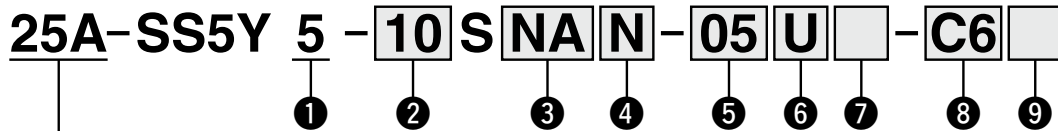

Series compatible with secondary batteries

### 1 Series

5	SY5000
---	--------

### 2 Type

10	Side ported
11	Bottom ported

### 3 SI unit specifications

Symbol	Protocol	Number of outputs	Communication connector
0	Without SI unit		
QA	DeviceNet™	32	M12
QB		16	
NA	PROFIBUS	32	
NB		DP	
VA	CC-Link	32	
VB		16	
DA	EtherCAT	32	
DB		16	
FA	PROFINET	32	
FB		16	
EA	EtherNet/IP™	32	
EB		16	

For SI unit part number, refer to page 35. DIN rail cannot be mounted without SI unit.

### 4 SI unit output polarity

Nil	Positive common
N	Negative common

- \* Ensure a match with the common specifications of the value to be used.
- \* Without SI unit, the symbol is nil.

### 8 A, B port size (Metric)

Symbol	A, B port	Type 10/ Side ported	Type 11/ Bottom ported
		SY5000	SY5000
C4	Straight ø4 One-touch fitting	●	●
C6		●	●
C8		●	●
CM*1		●	●
P, E port size (One-touch fittings)		ø10	ø10

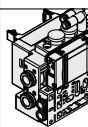

\*1 Indicate the sizes on the manifold specification sheet in the case of "CM."

### 5 Valve stations

In the case of the 32-output SI unit

Symbol	Stations	Note
02	2 stations	Double wiring*1
⋮	⋮	
16	16 stations	Specified layout*2 (Available up to 32 solenoids)
02	2 stations	
⋮	⋮	
24	24 stations	

In the case of the 16-output SI unit

Symbol	Stations	Note
02	2 stations	Double wiring*1
⋮	⋮	
08	8 stations	Specified layout*2 (Available up to 16 solenoids)
02	2 stations	
⋮	⋮	
16	16 stations	

- \*1 Double wiring: 2-position single, double, 3-position, and 4-position valves can be used on all manifold stations. Use of a 2-position single solenoid will result in an unused control signal. If this is not desired, order with a specified layout.
- \*2 Specified layout: Indicate the wiring specifications on the manifold specification sheet. (Note that 2-position double, 3-position, and 4-position valves cannot be used where single wiring has been specified.)
- \* This also includes the number of the blanking plate assembly.
- \* For the model without the SI unit (S0), note the maximum number of solenoids of the SI unit that will be mounted. If the layout is specified, indicate it on the manifold specification sheet.

### 6 P, E port entry

U	U side (2 to 10 stations)
D	D side (2 to 10 stations)
B	Both sides (2 to 24 stations)

### 7 SUP/EXH block assembly

Nil	Internal pilot
S	Internal pilot, Built-in silencer

- \* 3/5(E) port is plugged for the built-in silencer type.
- \* When the built-in silencer type is used, keep the exhaust port from coming in direct contact with water or other liquids.

### 9 Mounting

Symbol	Mounting
Nil	Direct mounting
D□	DIN rail mounting

- \* Enter the number of stations inside □. (Refer to "DIN Rail Option" below.)
- \* Only direct mounting is available for Type "11" (Bottom ported).

#### DIN rail option

Nil	Direct mounting
0	With DIN bracket (Without DIN rail)
3	For 3 stations
⋮	⋮
24	For 24 stations

- \* Specify a longer rail than the total length of specified stations.
- \* When it is necessary to mount a DIN rail without an SI unit, select "D0" and order DIN rail length separately, referring to L3 in the dimensions.

\* The 25A- series specifications and dimensions are the same as those of the standard model.

[Click here for details.](#)

For details about the EX260 Integrated-type (For Output) Serial Transmission System, refer to the Web Catalog and the Operation Manual. For details about part numbers of SI units to be mounted, refer to page 35 in this catalog. Please download the Operation Manual via our website, <https://www.smcworld.com>

**How to Order Valves (With two mounting screws)**

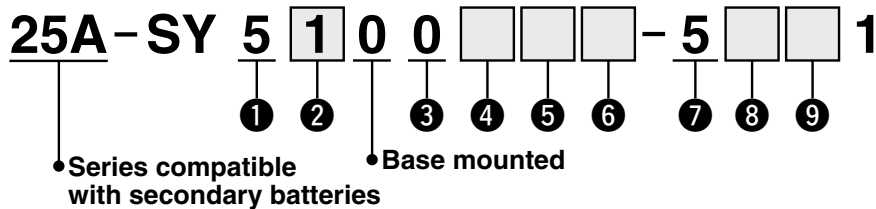

**1 Series**

5	SY5000
---	--------

**2 Type of actuation**

1	2-position single
2	2-position double
3	3-position closed center
4	3-position exhaust center
5	3-position pressure center
A	4-position dual 3-port valve (N.C./N.C.)
B	4-position dual 3-port valve (N.O./N.O.)
C	4-position dual 3-port valve (N.C./N.O.)

**3 Seal type**

0	Rubber seal
---	-------------

**4 Back pressure check valve (Built-in valve type)**

Nil	None
H	Built-in

\* The built-in valve type back pressure check valve is not available for the 3-position type.

**5 Pilot valve option**

Nil	Standard (0.7 MPa)
B	Quick response type (0.7 MPa)

**6 Coil type**

Nil	Standard
T	With power saving circuit (Continuous duty type)

\* Be sure to select the power saving circuit type when the valve is continuously energized for long periods of time.  
 \* Be careful of the energizing time when the power saving circuit is selected. For details, refer to the standard product catalog.

**7 Rated voltage**

5	24 VDC
---	--------

**8 Light/surge voltage suppressor and common specification**

R	With surge voltage suppressor (Non-polar)
U	With light/surge voltage suppressor (Non-polar)
S	With surge voltage suppressor (Positive common)
Z	With light/surge voltage suppressor (Positive common)
NS	With surge voltage suppressor (Negative common)
NZ	With light/surge voltage suppressor (Negative common)

\* Select a valve from "R," "U," "S" or "Z" when the SI unit output polarity is Nil (Positive common). Select a valve from "R," "U," "NS" or "NZ" when the SI unit output polarity is "N" (Negative common).  
 \* Only "Z" and "NZ" types are available for the product with power saving circuit.

**9 Manual override**

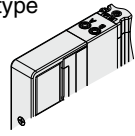
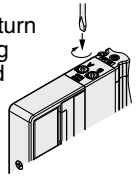
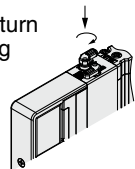
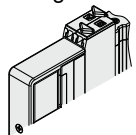
<p><b>Nil:</b> Non-locking push type</p> 	<p><b>D:</b> Push-turn locking slotted type</p> 
<p><b>E:</b> Push-turn locking lever type</p> 	<p><b>F:</b> Slide locking type</p> 

\* The 25A- series specifications and dimensions are the same as those of the standard model.

[Click here for details.](#)

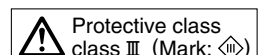

# Plug-in Connector Connecting Base

EX260



Type 12  
Top Ported

# 25A-SY5000 Series



## How to Order Manifold

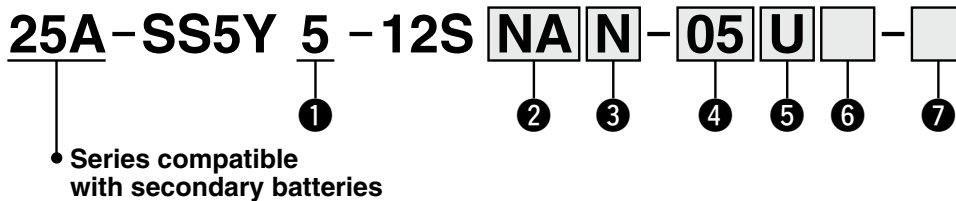

### 1 Series

5	SY5000
---	--------

### 2 SI unit specifications

Symbol	Protocol	Number of outputs	Communication connector
0	Without SI unit		
QA	DeviceNet™	32	M12
QB		16	
NA	PROFIBUS	32	
NB		16	
VA	CC-Link	32	
VB		16	
DA	EtherCAT	32	
DB		16	
FA	PROFINET	32	
FB		16	
EA	EtherNet/IP™	32	
EB		16	

For SI unit part number, refer to page 35. DIN rail cannot be mounted without SI unit.

### 3 SI unit output polarity

Nil	Positive common (NPN)
N	Negative common (PNP)

- \* Ensure a match with the common specifications of the value to be used.
- \* Without SI unit, the symbol is nil.

### 4 Valve stations

In the case of the 32-output SI unit

Symbol	Stations	Note
02	2 stations	Double wiring*1
⋮	⋮	
16	16 stations	Specified layout*2 (Available up to 32 solenoids)
02	2 stations	
⋮	⋮	
24	24 stations	

In the case of the 16-output SI unit

Symbol	Stations	Note
02	2 stations	Double wiring*1
⋮	⋮	
08	8 stations	Specified layout*2 (Available up to 16 solenoids)
02	2 stations	
⋮	⋮	
16	16 stations	

- \*1 Double wiring: 2-position single, double, 3-position, and 4-position valves can be used on all manifold stations. Use of a 2-position single solenoid will result in an unused control signal. If this is not desired, order with a specified layout.
- \*2 Specified layout: Indicate the wiring specifications on the manifold specification sheet. (Note that 2-position double, 3-position, and 4-position valves cannot be used where single wiring has been specified.)
- \* This also includes the number of the blanking plate assembly.
- \* For the model without the SI unit (S0), note the maximum number of solenoids of the SI unit that will be mounted. If the layout is specified, indicate it on the manifold specification sheet.

### 5 P, E port entry

U*1	U side (2 to 10 stations)
D*1	D side (2 to 10 stations)
B	Both sides (2 to 24 stations)

- \*1 6 For type "S," supply/exhaust block assembly with built-in silencer, choose "U" or "D" for P port entry.

### 6 SUP/EXH block assembly

Nil	Internal pilot
S	Internal pilot, Built-in silencer

- \* For built-in silencer type, P and E ports are available on U and D sides. 3/5(E) port is plugged. The silencer exhaust port is located on the opposite side of P, E port entry. (Example: When the P, E port entry is D side, the silencer exhaust port is U side.)
- \* When the built-in silencer type is used, keep the exhaust port from coming in direct contact with water or other liquids.

### 7 Mounting

Nil	Direct mounting	
D	DIN rail mounting (With DIN rail)	
D0	DIN rail mounting (Without DIN rail)	
D3	For 3 stations	Specify a longer rail than the standard length.
⋮	⋮	
D24	For 24 stations	

- \* When it is necessary to mount a DIN rail without an SI unit, select "D0" and order DIN rail length separately, referring to L3 in the dimensions.

\* The 25A- series specifications and dimensions are the same as those of the standard model.

[Click here for details.](#)

For details about the EX260 Integrated-type (For Output) Serial Transmission System, refer to the Web Catalog and the Operation Manual. For details about part numbers of SI units to be mounted, refer to page 35 in this catalog. Please download the Operation Manual via our website, <https://www.smcworld.com>

**How to Order Valves (With two mounting screws)**

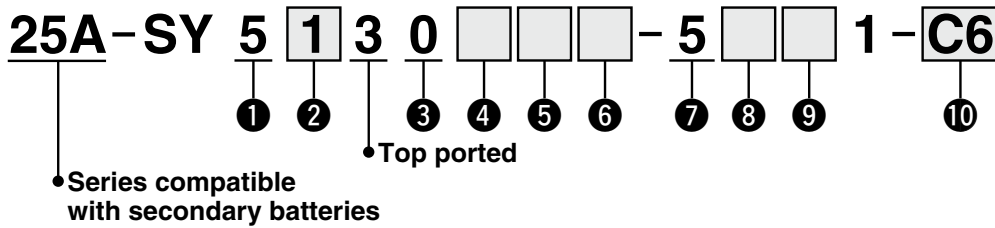

**1 Series**

5	SY5000
---	--------

**2 Type of actuation**

1	2-position single
2	2-position double
3	3-position closed center
4	3-position exhaust center
5	3-position pressure center
A	4-position dual 3-port valve (N.C./N.C.)
B	4-position dual 3-port valve (N.O./N.O.)
C	4-position dual 3-port valve (N.C./N.O.)

**3 Seal type**

0	Rubber seal
---	-------------

**4 Back pressure check valve (Built-in valve type)**

Nil	None
H	Built-in

\* The built-in valve type back pressure check valve is not available for the 3-position type.

**5 Pilot valve option**

Nil	Standard (0.7 MPa)
B	Quick response type (0.7 MPa)

**6 Coil type**

Nil	Standard
T	With power saving circuit (Continuous duty type)

\* Be sure to select the power saving circuit type when the valve is continuously energized for long periods of time.  
\* Be careful of the energizing time when the power saving circuit is selected. For details, refer to the standard product catalog.

**7 Rated voltage**

5	24 VDC
---	--------

**8 Light/surge voltage suppressor and common specification**

R	With surge voltage suppressor (Non-polar)
U	With light/surge voltage suppressor (Non-polar)
S	With surge voltage suppressor (Positive common)
Z	With light/surge voltage suppressor (Positive common)
NS	With surge voltage suppressor (Negative common)
NZ	With light/surge voltage suppressor (Negative common)

\* Select a valve from "R," "U," "S" or "Z" when the SI unit output polarity is Nil (Positive common). Select a valve from "R," "U," "NS" or "NZ" when the SI unit output polarity is "N" (Negative common).  
\* Only "Z" and "NZ" types are available for the product with power saving circuit.

**9 Manual override**

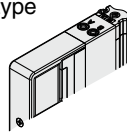
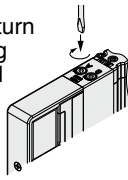
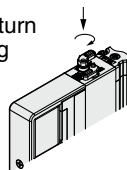
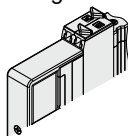
<p><b>Nil:</b> Non-locking push type</p> 	<p><b>D:</b> Push-turn locking slotted type</p> 
<p><b>E:</b> Push-turn locking lever type</p> 	<p><b>F:</b> Slide locking type</p> 

**10 A, B port size One-touch fitting (Metric)**

Symbol	A, B port	SY5000
C4	ø4 One-touch fitting	●
C6	ø6 One-touch fitting	●
C8	ø8 One-touch fitting	●

\* The 25A- series specifications and dimensions are the same as those of the standard model.

[Click here for details.](#)

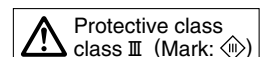

Type 10  
Side Ported

Type 11  
Bottom Ported

# Plug-in Connector Connecting Base

EX126



# 25A-SY5000 Series



## How to Order Manifold

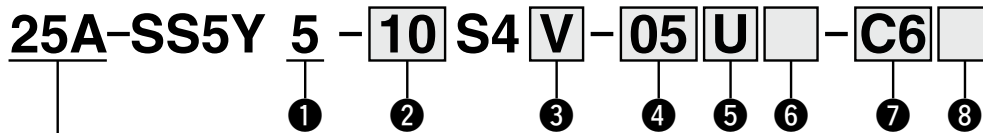

• Series compatible with secondary batteries

### 1 Series

5	SY5000
---	--------

### 2 Type

10	Side ported
11	Bottom ported

### 3 SI unit

0	Without SI unit
V	CC-Link (Positive common NPN)

\* Only a terminal block plate is mounted for the valve without SI unit.  
For SI unit part number, refer to page 35.

### 4 Valve stations

Symbol	Stations	Note
02	2 stations	Double wiring*1
⋮	⋮	
08	8 stations	
02	2 stations	Specified layout*2 (Available up to 16 solenoids)
⋮	⋮	
16	16 stations	

\*1 Double wiring: 2-position single, double, 3-position, and 4-position valves can be used on all manifold stations.  
Use of a 2-position single solenoid will result in an unused control signal. If this is not desired, order with a specified layout.

\*2 Specified layout: Indicate the wiring specifications on the manifold specification sheet. (Note that 2-position double, 3-position, and 4-position valves cannot be used where single wiring has been specified.)

\* This also includes the number of the blanking plate assembly.

### 5 P, E port entry

U	U side (2 to 10 stations)
D	D side (2 to 10 stations)
B	Both sides (2 to 16 stations)

### 6 SUP/EXH block assembly

Nil	Internal pilot
S	Internal pilot, Built-in silencer

\* 3/5(E) port is plugged for the built-in silencer type.  
\* When the built-in silencer type is used, keep the exhaust port from coming in direct contact with water or other liquids.

### 7 A, B port (Metric)

Symbol	A, B port	Type 10/ Side ported	Type 11/ Bottom ported
		SY5000	SY5000
C4	Straight ø4 One-touch fitting	●	●
C6		●	●
C8		●	●
CM*1	Straight port, mixed sizes	●	●
P, E port size (One-touch fittings)		ø10	ø10

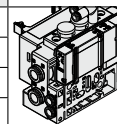

\*1 Indicate the size on the manifold specification sheet in the case of "CM."

\* The direction of P, E port fittings is the same as for the A, B port.

\* The 25A-series specifications and dimensions are the same as those of the standard model.

[Click here for details.](#)

For details about the EX126 Integrated-type (For Output) Serial Transmission System, refer to the Web Catalog and the Operation Manual. For details about part numbers of SI units to be mounted, refer to page 35 in this catalog. Please download the Operation Manual via our website, <https://www.smcworld.com>

**How to Order Valves (With two mounting screws)**

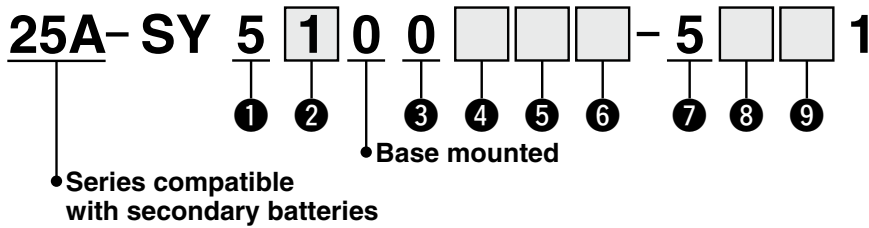

**1 Series**

5	SY5000
---	--------

**2 Type of actuation**

1	2-position single
2	2-position double
3	3-position closed center
4	3-position exhaust center
5	3-position pressure center
A	4-position dual 3-port valve (N.C./N.C.)
B	4-position dual 3-port valve (N.O./N.O.)
C	4-position dual 3-port valve (N.C./N.O.)

**3 Seal type**

0	Rubber seal
---	-------------

**4 Back pressure check valve (Built-in valve type)**

Nil	None
H	Built-in

\* The built-in valve type back pressure check valve is not available for the 3-position type.

**5 Pilot valve option**

Nil	Standard (0.7 MPa)
B	Quick response type (0.7 MPa)

**6 Coil type**

Nil	Standard
T	With power saving circuit (Continuous duty type)

\* Be sure to select the power saving circuit type when the valve is continuously energized for long periods of time.  
 \* Be careful of the energizing time when the power saving circuit is selected. For details, refer to the standard product catalog.

**7 Rated voltage**

5	24 VDC
---	--------

**8 Light/surge voltage suppressor and common specification**

R	With surge voltage suppressor (Non-polar)
U	With light/surge voltage suppressor (Non-polar)
S	With surge voltage suppressor (Positive common)
Z	With light/surge voltage suppressor (Positive common)

\* Only "Z" type is available for the product with power saving circuit.

**9 Manual override**

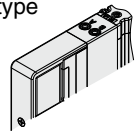
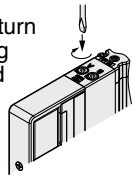
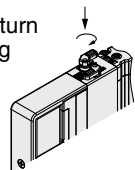
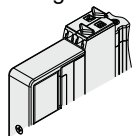
<p><b>Nil:</b> Non-locking push type</p> 	<p><b>D:</b> Push-turn locking slotted type</p> 
<p><b>E:</b> Push-turn locking lever type</p> 	<p><b>F:</b> Slide locking type</p> 

\* The 25A- series specifications and dimensions are the same as those of the standard model.

[Click here for details.](#)

# Plug-in Connector Connecting Base

EX126



Type 12  
Top Ported

# 25A-SY5000 Series



## How to Order Manifold

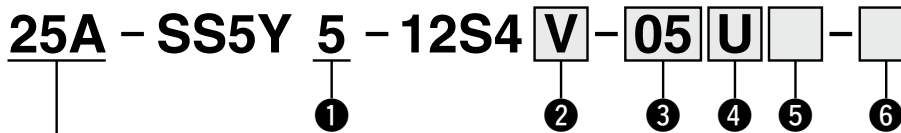

• Series compatible with secondary batteries

### 1 Series

5	SY5000
---	--------

### 2 SI unit

0	Without SI unit
V	CC-Link (Positive common NPN)

\* Only a terminal block plate is mounted for the valve without SI unit. For SI unit part number, refer to page 35.

### 3 Valve stations

Symbol	Stations	Note
02	2 stations	Double wiring*1
:	:	
08	8 stations	
02	2 stations	Specified layout*2 (Available up to 16 solenoids)
:	:	
16	16 stations	

- \*1 Double wiring: 2-position single, double, 3-position, and 4-position valves can be used on all manifold stations. Use of a 2-position single solenoid will result in an unused control signal. If this is not desired, order with a specified layout.
- \*2 Specified layout: Indicate the wiring specifications on the manifold specification sheet. (Note that 2-position double, 3-position, and 4-position valves cannot be used where single wiring has been specified.)
- \* This also includes the number of the blanking plate assembly.

### 4 P, E port entry

U*1	U side (2 to 10 stations)
D*1	D side (2 to 10 stations)
B	Both sides (2 to 16 stations)

\*1 For type "S," supply/exhaust block assembly with built-in silencer, choose "U" or "D" for P port entry.

### 5 SUP/EXH block assembly

Nil	Internal pilot
S	Internal pilot, Built-in silencer

- \* For built-in silencer type, P and E ports are available on U and D sides. 3/5(E) port is plugged. The silencer exhaust port is located on the opposite side of P, E port entry. (Example: When the P, E port entry is D side, the silencer exhaust port is U side.)
- \* When the built-in silencer type is used, keep the exhaust port from coming in direct contact with water or other liquids.

### 6 Mounting

Nil	Direct mounting	
D	DIN rail mounting (With DIN rail)	
D0	DIN rail mounting (Without DIN rail)	
D3	For 3 stations	Specify a longer rail than the standard length.
:	:	
D16	For 16 stations	

\* The 25A-series specifications and dimensions are the same as those of the standard model.

[Click here for details.](#)

For details about the EX126 Integrated-type (For Output) Serial Transmission System, refer to the Web Catalog and the Operation Manual. For details about part numbers of SI units to be mounted, refer to page 35 in this catalog. Please download the Operation Manual via our website, <https://www.smcworld.com>

### How to Order Valves (With two mounting screws)

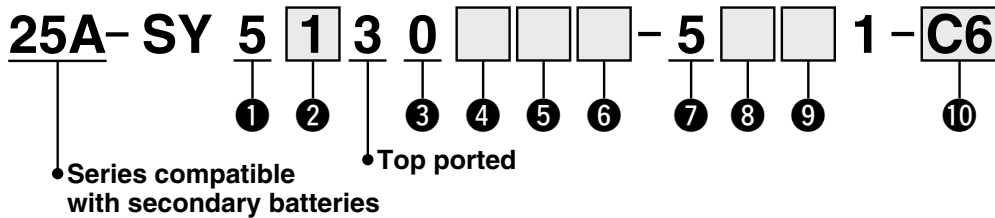

#### 1 Series

5	SY5000
---	--------

#### 2 Type of actuation

1	2-position single
2	2-position double
3	3-position closed center
4	3-position exhaust center
5	3-position pressure center
A	4-position dual 3-port valve (N.C./N.C.)
B	4-position dual 3-port valve (N.O./N.O.)
C	4-position dual 3-port valve (N.C./N.O.)

#### 3 Seal type

0	Rubber seal
---	-------------

#### 4 Back pressure check valve (Built-in valve type)

Nil	None
H	Built-in

\* The built-in valve type back pressure check valve is not available for the 3-position type.

#### 5 Pilot valve option

Nil	Standard (0.7 MPa)
B	Quick response type (0.7 MPa)

#### 6 Coil type

Nil	Standard
T	With power saving circuit (Continuous duty type)

\* Be sure to select the power saving circuit type when the valve is continuously energized for long periods of time.  
 \* Be careful of the energizing time when the power saving circuit is selected. For details, refer to the standard product catalog.

#### 7 Rated voltage

5	24 VDC
---	--------

#### 8 Light/surge voltage suppressor and common specification

R	With surge voltage suppressor (Non-polar)
U	With light/surge voltage suppressor (Non-polar)
S	With surge voltage suppressor (Positive common)
Z	With light/surge voltage suppressor (Positive common)

\* Only "Z" type is available for models with a power saving circuit.

#### 9 Manual override

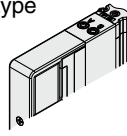
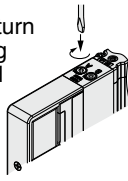
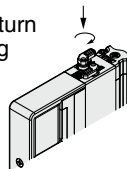
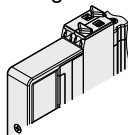
<b>Nil:</b> Non-locking push type 	<b>D:</b> Push-turn locking slotted type 
<b>E:</b> Push-turn locking lever type 	<b>F:</b> Slide locking type 

#### 10 A, B port size One-touch fitting (Metric)

Symbol	A, B port	SY5000
C4	ø4 One-touch fitting	●
C6	ø6 One-touch fitting	●
C8	ø8 One-touch fitting	●

\* The 25A- series specifications and dimensions are the same as those of the standard model.

[Click here for details.](#)

#### ⚠ Caution

Tightening torque for mounting screw M3: 0.8 N·m
---

### Manifold Options

#### ■ Blanking plate assembly

(With two mounting screws)  
 Used when valve additions are expected or for maintenance. A structure is in place on the blanking plate to prevent the mounting screws from sliding.

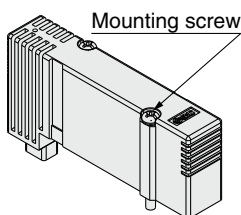

25A-SY50M-26-1A

#### How to Order Blanking Plate Assembly

**25A-SY 5 0M-26- 1 A**

5	SY5000
---	--------

1	For plug-in connector connecting base
---	---------------------------------------

\* The 25A- series specifications and dimensions are the same as those of the standard model.

[Click here for details.](#)

# 25A-SY5000 Series

## SI Unit Part Nos.

Description	SI unit part no.	Note
EX260 SI unit	<b>EX260-SPR1-X117</b>	PROFIBUS DP M12 connector, 32 outputs, Negative common (PNP)
	<b>EX260-SPR2-X117</b>	PROFIBUS DP M12 connector, 32 outputs, Positive common (NPN)
	<b>EX260-SPR3-X117</b>	PROFIBUS DP M12 connector, 16 outputs, Negative common (PNP)
	<b>EX260-SPR4-X117</b>	PROFIBUS DP M12 connector, 16 outputs, Positive common (NPN)
	<b>EX260-SDN1-X117</b>	DeviceNet™ M12 connector, 32 outputs, Negative common (PNP)
	<b>EX260-SDN2-X117</b>	DeviceNet™ M12 connector, 32 outputs, Positive common (NPN)
	<b>EX260-SDN3-X117</b>	DeviceNet™ M12 connector, 16 outputs, Negative common (PNP)
	<b>EX260-SDN4-X117</b>	DeviceNet™ M12 connector, 16 outputs, Positive common (NPN)
	<b>EX260-SEC1-X117</b>	EtherCAT M12 connector, 32 outputs, Negative common (PNP)
	<b>EX260-SEC2-X117</b>	EtherCAT M12 connector, 32 outputs, Positive common (NPN)
	<b>EX260-SEC3-X117</b>	EtherCAT M12 connector, 16 outputs, Negative common (PNP)
	<b>EX260-SEC4-X117</b>	EtherCAT M12 connector, 16 outputs, Positive common (NPN)
	<b>EX260-SMJ1-X117</b>	CC-Link M12 connector, 32 outputs, Negative common (PNP)
	<b>EX260-SMJ2-X117</b>	CC-Link M12 connector, 32 outputs, Positive common (NPN)
	<b>EX260-SMJ3-X117</b>	CC-Link M12 connector, 16 outputs, Negative common (PNP)
	<b>EX260-SMJ4-X117</b>	CC-Link M12 connector, 16 outputs, Positive common (NPN)
	<b>EX260-SPN1-X117</b>	PROFINET M12 connector, 32 outputs, Negative common (PNP)
	<b>EX260-SPN2-X117</b>	PROFINET M12 connector, 32 outputs, Positive common (NPN)
	<b>EX260-SPN3-X117</b>	PROFINET M12 connector, 16 outputs, Negative common (PNP)
	<b>EX260-SPN4-X117</b>	PROFINET M12 connector, 16 outputs, Positive common (NPN)
EX126 SI unit	<b>EX260-SEN1-X117</b>	EtherNet/IP™ M12 connector, 32 outputs, Negative common (PNP)
	<b>EX260-SEN2-X117</b>	EtherNet/IP™ M12 connector, 32 outputs, Positive common (NPN)
	<b>EX260-SEN3-X117</b>	EtherNet/IP™ M12 connector, 16 outputs, Negative common (PNP)
	<b>EX260-SEN4-X117</b>	EtherNet/IP™ M12 connector, 16 outputs, Positive common (NPN)
EX126 SI unit	<b>EX126D-SMJ1-X220</b>	CC-Link (Terminal block, 16 outputs, Positive common (NPN))

## Valve Mounting Screw Part No.

Description	Part no.	Note
	<b>25A-SS5Y5</b>	
Round head combination screw	<b>SY5000-223-1A</b>	Part numbers shown on the left are for 10 valves. (20 pcs.)

## One-touch Fittings Part Nos.

		Port size	25A-SY5000
A, B port	Metric size	ø4 One-touch fitting (Straight type)	<b>90-VVQ1000-51A-C4</b>
		ø6 One-touch fitting (Straight type)	<b>90-VVQ1000-51A-C6</b>
		ø8 One-touch fitting (Straight type)	<b>90-VVQ1000-51A-C8</b>
P, E port	Metric size	ø10 One-touch fitting (Straight type)	<b>90-VVQ2000-51A-C10</b>

## Manifold Options

### How to Order Individual SUP/EXH Spacer Assembly

One-touch fitting Straight type **25A-SY50M-38-1A-C6**

Series	5 SY5000
Spacer type	38 Individual SUP spacer 39 Individual EXH spacer

#### Port size (Metric)

Symbol	P, E port
<b>C4</b>	ø4 One-touch fitting
<b>C6</b>	ø6 One-touch fitting
<b>C8</b>	ø8 One-touch fitting

Part numbers of mounting screw (2 pcs. of each)  
SY5000: SY5000-223-2A

### How to Order Individual SUP/EXH Block Assembly

One-touch fitting Straight type **25A-SY50M-78-1A-C6**

Series	5 SY5000
Block type	78 Individual SUP block 79 Individual EXH block

#### Port size (Metric)

Symbol	P, E port
<b>C4</b>	ø4 One-touch fitting
<b>C6</b>	ø6 One-touch fitting
<b>C8</b>	ø8 One-touch fitting

# 5-Port Solenoid Valve Body Ported/Single Unit

## 25A-SY5000/7000 Series



### How to Order

25A - SY 5 1 20 [ ] - 5 L [ ] [ ] - 01 - [ ] - [ ]

Series compatible with secondary batteries

Series

5	SY5000
7	SY7000

Type of actuation

1	2-position single
2	2-position double
3	3-position closed center
4	3-position exhaust center
5	3-position pressure center

Coil specifications

Nil	Standard
T	With power saving circuit (24, 12 VDC only)

\* Power saving circuit is not available in the case of "D" or "Y" type.

For DC

5	24 VDC
6	12 VDC
V	6 VDC
S	5 VDC
R	3 VDC

Rated voltage

For AC (50/60 Hz)

1	100 VAC
2	200 VAC
3	110 VAC [115 VAC]
4	220 VAC [230 VAC]

\* DC specifications of type "D" and "Y" are only available with 12 and 24 VDC.

\* AC-type models that are CE-compliant have DIN terminals only.

Electrical entry

24, 12, 6, 5, 3 VDC/100, 110, 200, 220 VAC				24, 12 VDC/100, 110, 200, 220 VAC
Grommet	L plug connector	M plug connector	DIN terminal	
G: With lead wire (Length 300 mm)	L: With lead wire (Length 300 mm)	M: With lead wire (Length 300 mm)	MN: Without lead wire	D, Y: With connector
H: With lead wire (Length 600 mm)	LN: Without lead wire	LO: Without connector	MO: Without connector	

- \* "LN," "MN" type: with 2 sockets.
- \* "Y" type is a DIN terminal conforming to EN-175301-803C (former DIN43650C).
- \* Refer to the standard products for the lead wire length of L and M plug connectors and the connector assembly with cover for L and M plug connector.

CE-compliant

Nil	—
Q	CE-compliant

\* AC-type models that are CE-compliant have DIN terminals only.

Bracket

Nil	Without bracket
F1	With foot bracket (2-position single only)
F2	With side bracket

A, B port size Thread piping

Symbol	Port size	Applicable series
01	Rc 1/8	SY5000
02	Rc 1/4	SY7000

One-touch fitting (Metric size)

Symbol	Port size	Applicable series
C4	One-touch fitting for ø4	SY5000
C6	One-touch fitting for ø6	
C8	One-touch fitting for ø8	
C8	One-touch fitting for ø8	SY7000
C10	One-touch fitting for ø10	

Manual override

<p>Nil: Non-locking push type</p>	<p>D: Push-turn locking slotted type</p>	<p>E: Push-turn locking lever type</p>
-----------------------------------	--	--

Light/surge voltage suppressor

Electrical entry for G, H, L, M

Nil	Without light/surge voltage suppressor
S	With surge voltage suppressor
Z	With light/surge voltage suppressor
R	With surge voltage suppressor (Non-polar type)
U	With light/surge voltage suppressor (Non-polar type)

Electrical entry for D, Y

Nil	Without light/surge voltage suppressor
S	With surge voltage suppressor
Z	With light/surge voltage suppressor

\* There is no "S" type for AC mode, since a rectifier prevents surge voltage generation.

- \* There is no "S" type for AC mode, since a rectifier prevents surge voltage generation.
- \* For "R" and "U," DC voltage is only available.
- \* Power saving circuit is only available in the "Z" type.

\* When placing an order for body ported solenoid valve as a single unit, mounting screw for manifold and gasket are not attached. Order them separately, if necessary.

\* The 25A- series specifications and dimensions are the same as those of the standard model.

[Click here for details.](#)

# 5-Port Solenoid Valve Base Mounted/Single Unit 25A-SY5000/7000 Series



## How to Order

**25A - SY 5 2 40 [ ] [ ] - 5 L [ ] [ ] - [ ] - [ ]**

**Series compatible with secondary batteries**

Series	5	SY5000
7	SY7000	

**Type of actuation**

1	2-position single
2	2-position double
3	3-position closed center
4	3-position exhaust center
5	3-position pressure center

**Pilot type**

Nil	Internal pilot
R	External pilot

**Coil specifications**

Nil	Standard
T	With power saving circuit (24, 12 VDC only)

\* Power saving circuit is not available in the case of "D" or "Y" type.

**Rated voltage**

For DC	
5	24 VDC
6	12 VDC
V	6 VDC
S	5 VDC
R	3 VDC

**For AC (50/60Hz)**

1	100 VAC
2	200 VAC
3	110 VAC [115 VAC]
4	220 VAC [230 VAC]

\* DC specifications of type "D" and "Y" are only available with 12 and 24 VDC.  
\* AC-type models that are CE-compliant have DIN terminals only.

**CE-compliant**

Nil	—
Q	CE-compliant

\* AC-type models that are CE-compliant have DIN terminals only.

**Port size**

Symbol	Port size	Applicable series
Nil	Without sub-plate	
02	Rc 1/4 With sub-plate	SY5000 SY7000
03	Rc 3/8 With sub-plate	SY7000

**Manual override**

<b>Nil:</b> Non-locking push type	<b>D:</b> Push-turn locking slotted type	<b>E:</b> Push-turn locking lever type
-----------------------------------	--	--

**Light/surge voltage suppressor**

Electrical entry for G, H, L, M		Electrical entry for D, Y	
Nil	Without light/surge voltage suppressor	Nil	Without light/surge voltage suppressor
S	With surge voltage suppressor	S	With surge voltage suppressor (Non-polar type)
Z	With light/surge voltage suppressor	Z	With light/surge voltage suppressor (Non-polar type)
R	With surge voltage suppressor (Non-polar type)		
U	With light/surge voltage suppressor (Non-polar type)		

\* There is no "S" type for AC mode, since a rectifier prevents surge voltage generation.  
\* For "R" and "U," DC voltage is only available.  
\* Power saving circuit is only available in the "Z" type.

**Electrical entry**

24, 12, 6, 5, 3 VDC / 100, 110, 200, 220 VAC				24, 12 VDC / 100, 110, 200, 220 VAC
Grommet	L plug connector	M plug connector	MN: Without lead wire	D, Y: With connector
G: With lead wire (Length 300 mm)	L: With lead wire (Length 300 mm)	M: With lead wire (Length 300 mm)	MN: Without lead wire	
H: With lead wire (Length 600 mm)	LN: Without lead wire	LO: Without connector	MO: Without connector	

\* "LN," "MN" type: with 2 sockets.  
\* "Y" type is a DIN terminal conforming to EN-175301-803C (former DIN43650C).  
\* Refer to the standard products for the lead wire length of L and M plug connectors and the connector assembly with cover for L and M plug connector.

\* The 25A- series specifications and dimensions are the same as those of the standard model.

[Click here for details.](#)

# 5-Port Solenoid Valve Body Ported Manifold Bar Stock Type/Individual Wiring



Type **20**

# 25A-SY5000/7000 Series

## How to Order Manifold

25A – SS5Y **5** – 20 – **05** –

• Series compatible with secondary batteries

• Manifold series

5	SY5000
7	SY7000

• CE-compliant

Nil	—
Q	CE-compliant

\* AC-type models that are CE-compliant have DIN terminals only.

• Stations

02	2 stations
⋮	⋮
20	20 stations

\* This also includes the number of the blanking plate assembly.

\* The 25A- series specifications and dimensions are the same as those of the standard model. However, the blanking plate assembly has different dimensions. Refer to page 42.

[Click here for details.](#)

Directional Control Valves

Air Cylinders

Related Products

Rotary Actuators

Air Grippers

Vacuum Equipment

Air Preparation Equipment

Clean Air Filters

Modular F.R.L./Pressure Control Equipment

Fittings/Flow Control Equipment

Detection Switches

Fluid Control Equipment

Electric Actuators

Auto Switches

## How to Order Valves

25A – SY 5 1 20 [ ] – 5 L [ ] [ ] – 01 – [ ]

• Series compatible with secondary batteries

Series

5	SY5000
7	SY7000

Type of actuation

1	2-position single
2	2-position double
3	3-position closed center
4	3-position exhaust center
5	3-position pressure center

Coil specifications

Nil	Standard
T	With power saving circuit (24 VDC, 12 VDC only)

\* Power saving circuit is not available in the case of “D” or “Y” type.

Rated voltage

For DC		For AC (50/60Hz)	
5	24 VDC	1	100 VAC
6	12 VDC	2	200 VAC
V	6 VDC	3	110 VAC [115 VAC]
S	5 VDC	4	220 VAC [230 VAC]
R	3 VDC		

\* DC specifications of type “D” and “Y” are only available with 12 and 24 VDC.  
\* AC-type models that are CE-compliant have DIN terminals only.

• CE-compliant

Nil	—
Q	CE-compliant

\* AC-type models that are CE-compliant have DIN terminals only.

• A, B port size Thread piping

Symbol	Port size	Applicable series
01	Rc 1/8	SY5000
02	Rc 1/4	SY7000

One-touch fitting (Metric size)

Symbol	Port size	Applicable series
C4	One-touch fitting for ø4	SY5000
C6	One-touch fitting for ø6	
C8	One-touch fitting for ø8	
C8	One-touch fitting for ø8	SY7000
C10	One-touch fitting for ø10	

• Manual override

Nil	Non-locking push type
D	Push-turn locking slotted type
E	Push-turn locking lever type

• Light/surge voltage suppressor

Electrical entry for G, H, L, M

Nil	Without light/surge voltage suppressor
S	With surge voltage suppressor
Z	With light/surge voltage suppressor
R	With surge voltage suppressor (Non-polar type)
U	With light/surge voltage suppressor (Non-polar type)

\* There is no “S” type for AC mode, since a rectifier prevents surge voltage generation.  
\* For “R” and “U,” DC voltage is only available.  
\* Power saving circuit is only available in the “Z” type.

Electrical entry for D, Y

Nil	Without light/surge voltage suppressor
S	With surge voltage suppressor (Non-polar type)
Z	With light/surge voltage suppressor (Non-polar type)

\* There is no “S” type for AC mode, since a rectifier prevents surge voltage generation.

Electrical entry

24, 12, 6, 5, 3 VDC/100, 110, 200, 220 VAC			24, 12 VDC/ 100, 110, 200, 220 VAC
Grommet	L plug connector	M plug connector	DIN terminal
G: With lead wire (Length 300 mm) H: With lead wire (Length 600 mm)	L: With lead wire (Length 300 mm) LN: Without lead wire LO: Without connector	M: With lead wire (Length 300 mm) MN: Without lead wire MO: Without connector	D: With connector Y: With connector

\* “LN,” “MN” type: with 2 sockets.  
\* “Y” type is a DIN terminal conforming to EN-175301-803C (former DIN43650C).  
\* Refer to the standard products for the lead wire length of L and M plug connectors and the connector assembly with cover for L and M plug connector.

\* The 25A- series specifications and dimensions are the same as those of the standard model.

[Click here for details.](#)

Type **41**

Type **42**

# 5-Port Solenoid Valve Base Mounted Manifold Bar Stock Type/Individual Wiring

CE [Option]

## 25A-SY5000/7000 Series

### How to Order Manifold

#### Type 41/Compact type

**25A – SS5Y 5 – 41 – 05 – C8 –** [ ]

• Series compatible with secondary batteries

Manifold series

5	SY5000
---	--------

Stations

02	2 stations
⋮	⋮
20	20 stations

\* This also includes the number of the blanking plate assembly.

• CE-compliant

Nil	—
Q	CE-compliant

\* AC-type models that are CE-compliant have DIN terminals only.

• A, B port size  
Thread piping

Symbol	Port size	Applicable series
01	Rc 1/8	SY5000

One-touch fitting (Metric size)

Symbol	Port size	Applicable series
C6	One-touch fitting for ø6	SY5000
C8	One-touch fitting for ø8	

One-touch fitting (Inch size)

Symbol	Port size	Applicable series
N7	One-touch fitting for ø1/4"	SY5000
N9	One-touch fitting for ø5/16"	

#### Type 42/External pilot capable

**25A – SS5Y 5 – 42 – 05 – C8 –** [ ]

• Series compatible with secondary batteries

Manifold series

5	SY5000
7	SY7000

Stations

02	2 stations
⋮	⋮
20	20 stations

\* This also includes the number of the blanking plate assembly.

• CE-compliant

Nil	—
Q	CE-compliant

\* AC-type models that are CE-compliant have DIN terminals only.

• A, B port size  
Thread piping

Symbol	Port size	Applicable series
02	Rc 1/4	SY5000
02	Rc 1/4	SY7000

One-touch fitting (Metric size)

Symbol	Port size	Applicable series
C6	One-touch fitting for ø6	SY5000
C8	One-touch fitting for ø8	
C10	One-touch fitting for ø10	SY7000

One-touch fitting (Inch size)

Symbol	Port size	Applicable series
N7	One-touch fitting for ø1/4"	SY5000
N9	One-touch fitting for ø5/16"	
N11	One-touch fitting for ø3/8"	SY7000

\* The 25A- series specifications and dimensions are the same as those of the standard model. However, the blanking plate assembly has different dimensions. Refer to page 42.

[Click here for details.](#)

## How to Order Valves

25A – SY 5 2 40 [ ] [ ] – 5 L [ ] [ ] – [ ]

• **Series compatible with secondary batteries**

**Series**

5	SY5000
7	SY7000

• **Type of actuation**

1	2-position single
2	2-position double
3	3-position closed center
4	3-position exhaust center
5	3-position pressure center

• **Pilot type**

Nil	Internal pilot
R	External pilot

• **Coil specifications**

Nil	Standard
T	With power saving circuit (24 VDC, 12 VDC only)

\* Power saving circuit is not available in the case of "D" or "Y" type.

• **Rated voltage**

For DC	
5	24 VDC
6	12 VDC
V	6 VDC
S	5 VDC
R	3 VDC

For AC (50/60Hz)	
1	100 VAC
2	200 VAC
3	110 VAC [115 VAC]
4	220 VAC [230 VAC]

\* DC specifications of type "D" and "Y" are only available with 12 and 24 VDC.

\* AC-type models that are CE-compliant have DIN terminals only.

• **CE-compliant**

Nil	—
Q	CE-compliant

\* AC-type models that are CE-compliant have DIN terminals only.

• **Manual override**

Nil	Non-locking push type
D	Push-turn locking slotted type
E	Push-turn locking lever type

• **Light/surge voltage suppressor**

**Electrical entry for G, H, L, M**

Nil	Without light/surge voltage suppressor
S	With surge voltage suppressor
Z	With light/surge voltage suppressor
R	With surge voltage suppressor (Non-polar type)
U	With light/surge voltage suppressor (Non-polar type)

\* There is no "S" type for AC mode, since a rectifier prevents surge voltage generation.

\* For "R" and "U," DC voltage is only available.

\* Power saving circuit is only available in the "Z" type.

**Electrical entry for D, Y**

Nil	Without light/surge voltage suppressor
S	With surge voltage suppressor (Non-polar type)
Z	With light/surge voltage suppressor (Non-polar type)

\* There is no "S" type for AC mode, since a rectifier prevents surge voltage generation.

• **Electrical entry**

24, 12, 6, 5, 3 VDC/100, 110, 200, 220 VAC			24, 12 VDC/ 100, 110, 200, 220 VAC
Grommet	L plug connector	M plug connector	DIN terminal
<b>G:</b> With lead wire (Length 300 mm)	<b>L:</b> With lead wire (Length 300 mm)	<b>M:</b> With lead wire (Length 300 mm)	<b>D:</b> With connector
<b>H:</b> With lead wire (Length 600 mm)	<b>LN:</b> Without lead wire	<b>MN:</b> Without lead wire	<b>Y:</b> With connector
	<b>LO:</b> Without connector	<b>MO:</b> Without connector	

\* "LN," "MN" type: with 2 sockets.

\* "Y" type is a DIN terminal conforming to EN-175301-803C (former DIN43650C).

\* Refer to the standard products for the lead wire length of L and M plug connectors and the connector assembly with cover for L and M plug connector.

\* The 25A- series specifications and dimensions are the same as those of the standard model.

[Click here for details.](#)

# 5-Port Solenoid Valve **25A-SY5000/7000 Series**

## One-touch Fittings Part Nos. for Body Ported

Port size		25A-SY5000	25A-SY7000
Cylinder port	Metric size	ø4 One-touch fitting (Straight type)	90-VVQ1000-51A-C4
		ø6 One-touch fitting (Straight type)	90-VVQ1000-51A-C6
		ø8 One-touch fitting (Straight type)	90-VVQ1000-51A-C8
		ø10 One-touch fitting (Straight type)	90-VVQ2000-51A-C8 90-VVQ2000-51A-C10

## Gasket Assembly Part Nos.

Valve model	Manifold type	25A-SY5000	25A-SY7000
Body ported	Type 20	SY5000-GS-3	SY7000-GS-3
Base mounted	Type 41/42	SY5000-GS-4 (-Q)	SY7000-GS-4 (-Q)

\* The gasket assembly includes 10 sets of a gasket and mounting screws.

## Bracket Assembly Part Nos.

Description	Part no.
Bracket (For F1)	25A-SX <sup>5</sup> 000-16-2A (With mounting screw)
Bracket (For F2)	25A-SX <sup>5</sup> 000-16-1A (With mounting screw)

## Manifold Options

### Blanking plate assembly

(Mounting screw: 2 pcs., with gasket)

It is used by attaching on the manifold block for being prepared for removing a valve for maintenance reasons or planning to mount a spare valve, etc.

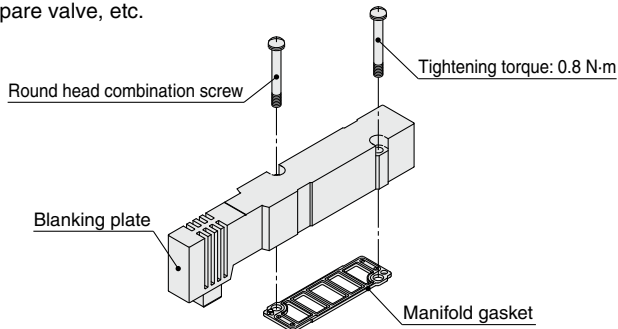

### How to Order

25A - SY **5** 000 - 26 - 1A

#### Series

5	25A-SY5000
7	25A-SY7000

### Caution

When mounted on a type 20 manifold, only the P port is plugged. In addition, it cannot be used for the type 20 CE-compliant manifold.

## Dimensions

### Manifold type/For type 20

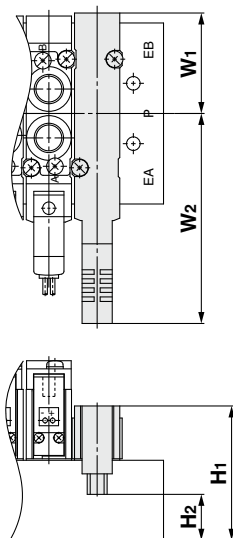

### Dimensions

Series	Manifold type	W <sub>1</sub>	W <sub>2</sub>	H <sub>1</sub>	H <sub>2</sub>
25A-SY5000	Type 20	33.3	69.6	44.5	15.2
25A-SY7000	Type 20	39.4	76.4	41.1	18.3

### Manifold type/For type 41/42

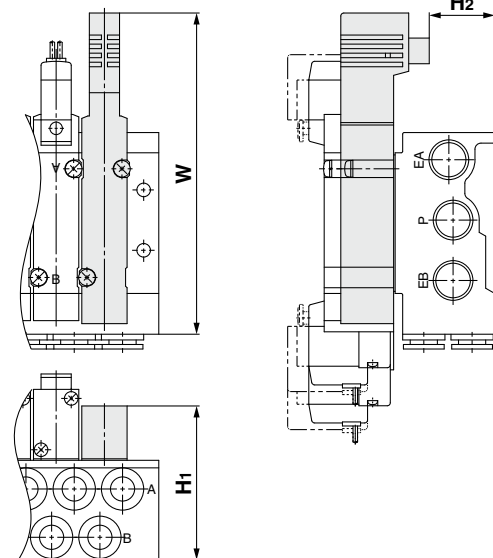

### Dimensions

Series	Manifold type	W	H <sub>1</sub>	H <sub>2</sub>
25A-SY5000	Type 41	106.4	51	21.7
	Type 42	107.6	56	26.7
25A-SY7000	Type 42	118.1	55.6	32.8

# Plug-in Unit/Base Mounted F Kit (D-sub connector kit) 25A-VQ2000 Series

## How to Order Manifold

\* For CE-compliant models, DC-type only.  [Option]

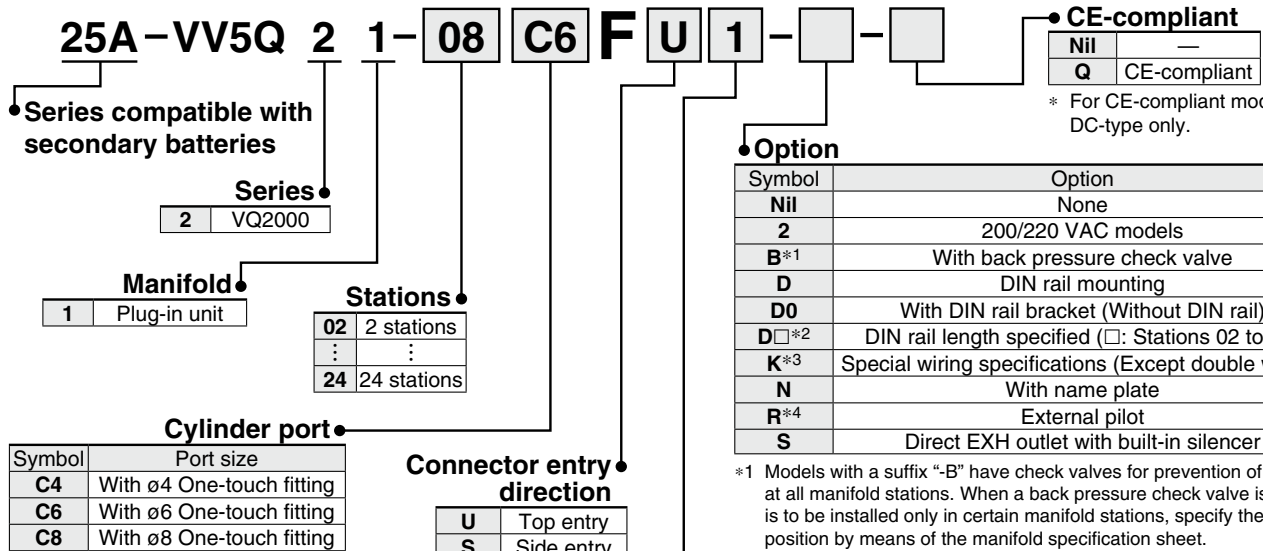

- \*1 Models with a suffix "-B" have check valves for prevention of back pressure at all manifold stations. When a back pressure check valve is desired, and is to be installed only in certain manifold stations, specify the mounting position by means of the manifold specification sheet.
- \*2 The number of stations that may be displayed is longer than the manifold number of stations.
- \*3 Specify the wiring specifications by means of the manifold specification sheet.
- \*4 Indicate "R" for the valve with external pilot.
- \* When two or more symbols are specified, indicate them alphabetically. Example) -BRS

## How to Order Valves

\* For CE-compliant models, DC-type only.  [Option]

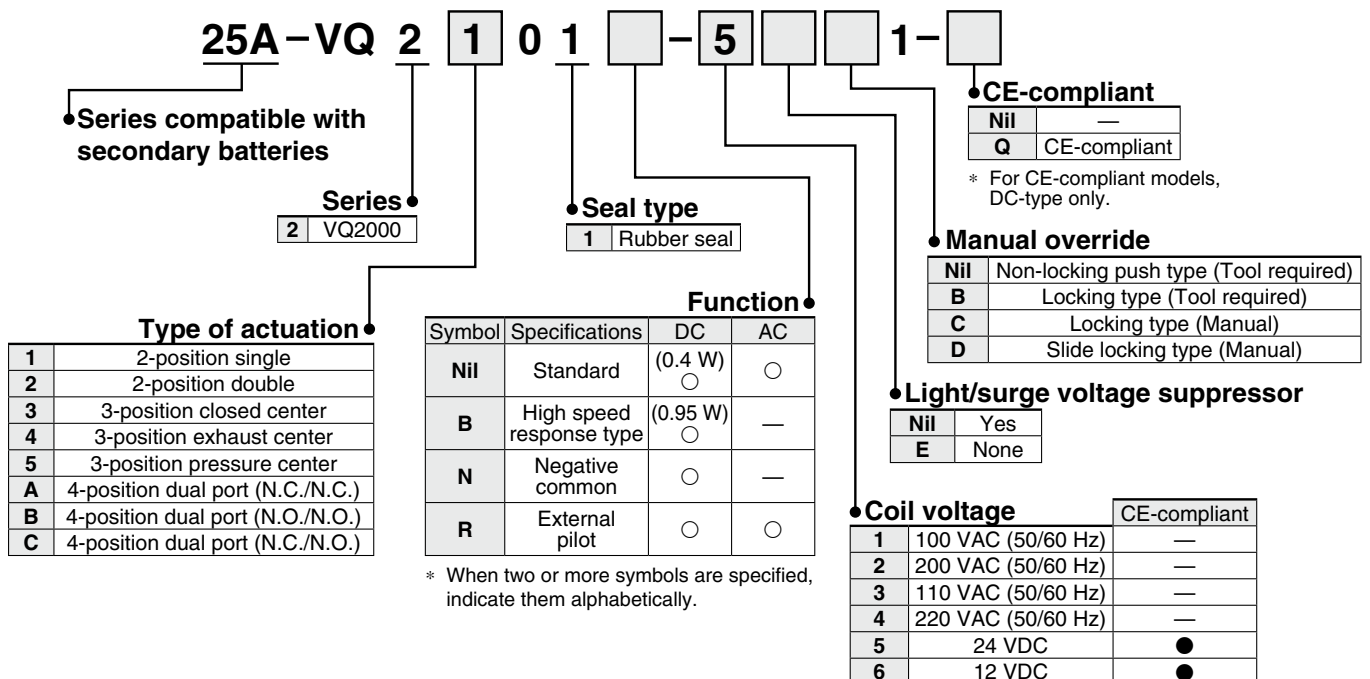

**Caution**  
Use the standard (DC) specification when continuously energizing for long periods of time.

\* The 25A- series specifications and dimensions are the same as those of the standard model.

[Click here for details.](#)

# Plug-in Unit/Base Mounted T Kit (Terminal block box kit) 25A-VQ2000 Series

## How to Order Manifold

\* For CE-compliant models, DC-type only.  [Option]

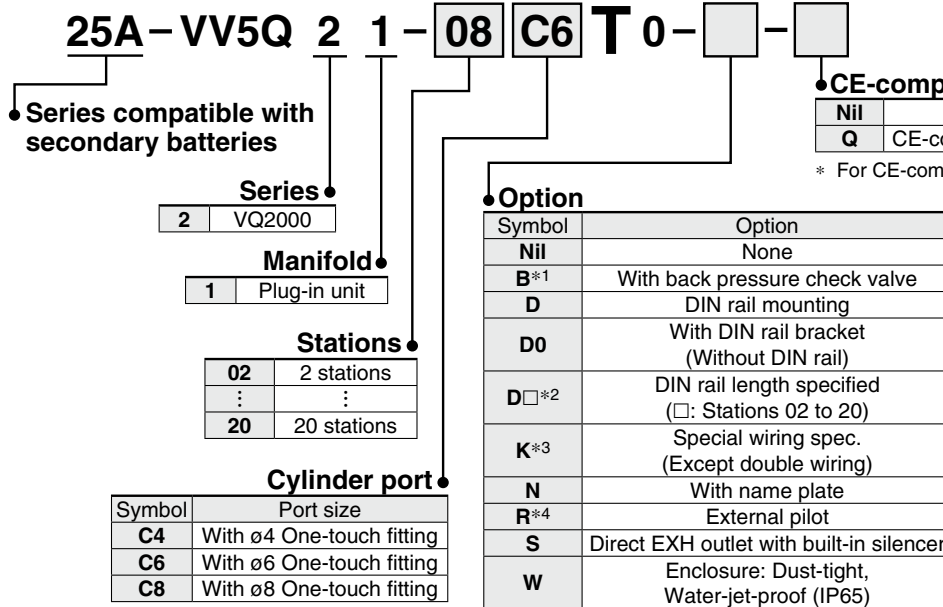

• CE-compliant

Nil	—
Q	CE-compliant

\* For CE-compliant models, DC-type only.

- \*1 Models with a suffix "B" have check valves for prevention of back pressure at all manifold stations. When a back pressure check valve is desired, and is to be installed only in certain manifold stations, specify the mounting position by means of the manifold specification sheet.
- \*2 The number of stations that may be displayed is longer than the manifold number of stations.
- \*3 Specify the wiring specifications by means of the manifold specification sheet.
- \*4 Indicate "R" for the valve with external pilot.
- \* When two or more symbols are specified, indicate them alphabetically. Example) -BRS
- \* Specify the mounting position by means of the manifold specification sheet.

## How to Order Valves

\* For CE-compliant models, DC-type only.  [Option]

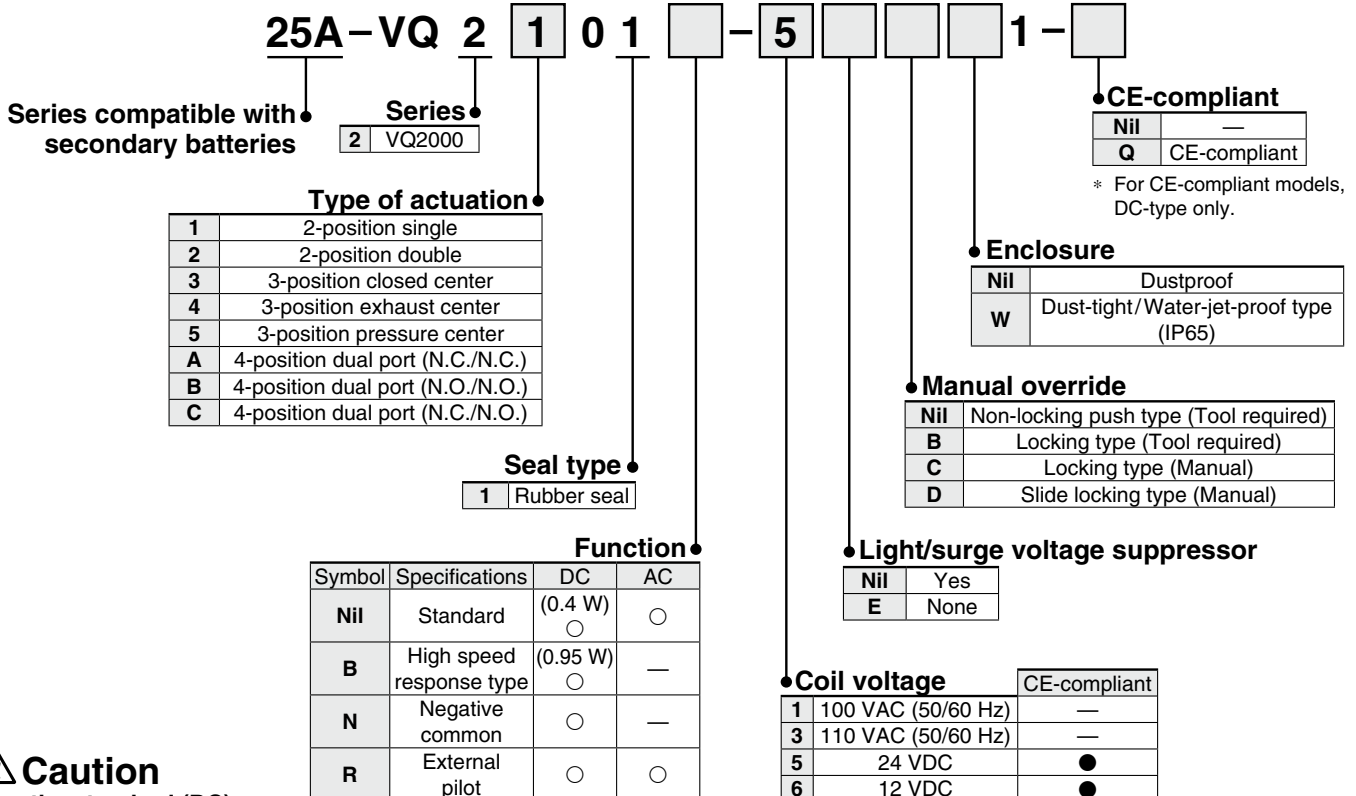

**⚠ Caution**  
Use the standard (DC) specification when continuously energizing for long periods of time.

\* When two or more symbols are specified, indicate them alphabetically. Combination of "B" and "K" is not possible.

\* The 25A- series specifications and dimensions are the same as those of the standard model.

[Click here for details.](#)

# Plug-in Unit/Base Mounted L Kit (Lead wire) 25A-VQ2000 Series

## How to Order Manifold

\* For CE-compliant models, DC-type only.  [Option]

**25A-VV5Q 2 1-06 C6 L 1 - -**

• Series compatible with secondary batteries

**Series**

2	VQ2000
---	--------

**Manifold**

1	Plug-in unit
---	--------------

**Stations**

01	1 station
⋮	⋮
08	8 stations

**Cylinder port**

Symbol	Port size
C4	With ø4 One-touch fitting
C6	With ø6 One-touch fitting
C8	With ø8 One-touch fitting

**Cable (Length)**

0	Cable length 0.6 m
1	Cable length 1.5 m
2	Cable length 3 m

**CE-compliant**

Nil	—
Q	CE-compliant

\* For CE-compliant models, DC-type only.

**Option**

Symbol	Option
Nil	None
2	200/220 VAC models
B*1	With back pressure check valve
D	DIN rail mounting
D0	With DIN rail bracket (Without DIN rail)
D□*2	DIN rail length specified (□: Stations 02 to 08)
N	With name plate
R*3	External pilot
S	Direct EXH outlet with built-in silencer
W	Enclosure: Dust-tight, Water-jet-proof (IP65)

\*1 Models with a suffix “-B” have check valves for prevention of back pressure at all manifold stations. When a back pressure check valve is desired, and is to be installed only in certain manifold stations, specify the mounting position by means of the manifold specification sheet.  
\*2 The number of stations that may be displayed is longer than the manifold a number of stations.  
\*3 Indicate “R” for the valve with external pilot.  
\* When two or more symbols are specified, indicate them alphabetically.  
Example) -BRS

## How to Order Valves

\* For CE-compliant models, DC-type only.  [Option]

**25A-VQ 2 1 0 1 - 5 - - - 1 -**

• Series compatible with secondary batteries

**Series**

2	VQ2000
---	--------

**Type of actuation**

1	2-position single
2	2-position double
3	3-position closed center
4	3-position exhaust center
5	3-position pressure center
A	4-position dual port (N.C./N.C.)
B	4-position dual port (N.O./N.O.)
C	4-position dual port (N.C./N.O.)

**Seal type**

1	Rubber seal
---	-------------

**Function**

Symbol	Specifications	DC (0.4 W)	AC
Nil	Standard	○	○
B	High speed response type	○	—
N	Negative common	○	—
R	External pilot	○	○

\* When two or more symbols are specified, indicate them alphabetically.

**CE-compliant**

Nil	—
Q	CE-compliant

\* For CE-compliant models, DC-type only.

**Enclosure**

Nil	Dustproof
W	Dust-tight/Water-jet-proof type (IP65)

**Manual override**

Nil	Non-locking push type (Tool required)
B	Locking type (Tool required)
C	Locking type (Manual)
D	Slide locking type (Manual)

**Light/surge voltage suppressor**

Nil	Yes
E	None

**Coil voltage**

	CE-compliant
1	100 VAC (50/60 Hz) —
2	200 VAC (50/60 Hz) —
3	110 VAC (50/60 Hz) —
4	220 VAC (50/60 Hz) —
5	24 VDC ●
6	12 VDC ●

\* The 25A- series specifications and dimensions are the same as those of the standard model. [Click here for details.](#)

# Plug-in Unit/Base Mounted S Kit (Serial transmission) 25A-VQ2000 Series

\* Refer to "SI Unit Part Nos." when ordering the CE-compliant SI unit.  [Option]

## How to Order Manifold

25A-VV5Q 2 1 - 08 C6 S V - [ ] - [ ]

• Series compatible with secondary batteries

Series  
2 VQ2000

Manifold  
1 Plug-in unit

Stations

02	2 stations
⋮	⋮
16*1	16 stations

\*1 Max. 16 stations.  
(Specify a model with 9 to 16 stations by means of the manifold specification sheet.)

• Cylinder port

Symbol	Port size
C4	With ø4 One-touch fitting
C6	With ø6 One-touch fitting
C8	With ø8 One-touch fitting

• SI unit specifications

Symbol	Protocol	Stations
0	Without SI unit	—
Q	DeviceNet™ System	Max.16 stations
V	CC-Link	Max.16 stations

• CE-compliant

Nil	—
Q	CE-compliant

\* Refer to "SI Unit Part Nos." when ordering the CE-compliant SI unit.

• Option

Symbol	Option
Nil	None
B*1	With back pressure check valve
D	DIN rail mounting
D□*2	DIN rail length specified (□: Stations 02 to 16)
K*3	Special wiring specifications (Except double wiring)
N	With name plate
R*4	With external pilot
S	Direct EXH outlet with built-in silencer
W*5	Enclosure: Dust-tight, Water-jet-proof (IP65)

\*1 Models with a suffix "-B" have check valves for prevention of back pressure at all manifold stations. When a back pressure check valve is desired, and is to be installed only in certain manifold stations, specify the mounting position by means of the manifold specification sheet.

\*2 The number of stations that may be displayed is longer than the manifold number of stations.

\*3 Specify the wiring specifications by means of the manifold specification sheet.

\*4 Indicate "R" for the valve with external pilot.

\*5 Refer to "Dimensions" of the standard products for SI unit and valve, in case of "W" (Dust-tight, Water-jet-proof).

\* When two or more symbols are specified, indicate them alphabetically.  
Example) -BRS.

• SI Unit Part Nos.

Symbol	Protocol	SI unit part no.
Q	DeviceNet™	EX120-SDN1-X220
V	CC-Link	EX120-SMJ1-X220

• SI Unit Part Nos. (With option W)

Symbol	Protocol	SI unit part no.
Q	DeviceNet™	EX124D-SDN1-X220
V	CC-Link	EX124D-SMJ1-X220

## How to Order Valves

 [Option]

25A-VQ 2 1 0 1 [ ] - 5 [ ] [ ] 1 - [ ]

• Series compatible with secondary batteries

Series  
2 VQ2000

• Type of actuation

1	2-position single
2	2-position double
3	3-position closed center
4	3-position exhaust center
5	3-position pressure center
A	4-position dual port (N.C./N.C.)
B	4-position dual port (N.O./N.O.)
C	4-position dual port (N.C./N.O.)

• Seal type

1 Rubber seal

• CE-compliant

Nil	—
Q	CE-compliant

• Manual override

Nil	Non-locking push type (Tool required)
B	Locking type (Tool required)
C	Locking type (Manual)
D	Slide locking type (Manual)

• Enclosure

Nil	Dustproof
W	Dust-tight/Water-jet-proof type (IP65)

• Function

Symbol	Specifications	DC
Nil	Standard	(0.4 W) ○
B	High speed response type	(0.95 W) ○
N*1	Negative common	○
R*1	External pilot	○

\*1 External pilot and negative common specifications are the same as standard products.

\* When two or more symbols are specified, indicate them alphabetically.

• Coil voltage

5	24 VDC; With indicator light/ surge voltage suppressor
---	--

\* The 25A- series specifications and dimensions are the same as those of the standard model. [Click here for details.](#)

# Sub-plate Single Unit

# 25A-VQ2000 Series



\* For CE-compliant models, DC-type only. [Option]

## How to Order

In the case of **Valve** + **Sub-plate**

25A-VQ2 **1** **0** **1**-**5** **W** 1-02 **□**-**□**

Series compatible with secondary batteries

Entry is the same as standard products.

Enclosure

Nil	Dustproof
W*1	Dust-tight/Water-jet-proof type (IP65)

\*1 Valves are IP65 specifications.

\* When the valve is a standard (dust-protected) specification, it is not compatible with 200 or 220 VAC.

CE-compliant

Nil	—
Q	CE-compliant

\* For CE-compliant models, DC-type only.

Thread type

Nil	Rc
N	NPT
T	NPTF
F	G

Port size

02	1/4
----	-----

In the case of **Sub-plate** alone

25A-VQ2000-PW-02

\* The 25A- series specifications and dimensions are the same as those of the standard model.

[Click here for details.](#)

## Manifold Options

### Blanking plate assembly

#### 25A-VVQ2000V-10A-1

It is used by attaching on the manifold block for being prepared for removing a valve for maintenance reasons or planning to mount a spare valve, etc.

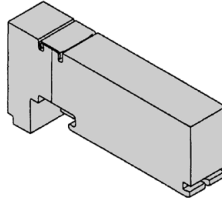

\* The 25A- series specifications and dimensions are the same as those of the standard model.

[Click here for details.](#)

### SI Unit Part Nos.

Description	SI unit part no.	Note
EX124 SI unit	<b>EX124D-SMJ1-X220</b>	CC-Link
	<b>EX124D-SDN1-X220</b>	DeviceNet™
EX120 SI unit	<b>EX120-SMJ1-X220</b>	CC-Link (VQ2000/Without option "W")
	<b>EX120-SDN1-X220</b>	DeviceNet™ (VQ2000/Without option "W")

### One-touch Fittings Part Nos.

Port size		One-touch fitting part no.	
Cylinder port	Metric size	ø4 One-touch fitting (Straight type)	<b>90-VVQ1000-51A-C4</b>
		ø6 One-touch fitting (Straight type)	<b>90-VVQ1000-51A-C6</b>
		ø8 One-touch fitting (Straight type)	<b>90-VVQ1000-51A-C8</b>
1 (P), 3 (R) port	Metric size	ø10 One-touch fitting (Straight type)	<b>90-VVQ2000-51A-C10</b>

Directional  
Control Valves

Air Cylinders

Related  
Products

Rotary  
Actuators

Air Grippers

Vacuum  
Equipment

Air Preparation  
Equipment

Clean  
Air Filters

Modular F.R.L./Pressure  
Control Equipment

Fittings/Flow  
Control Equipment

Detection  
Switches

Fluid Control  
Equipment

Electric  
Actuators

Auto  
Switches

# Plug-in/Plug Lead: Single Unit Base Mounted 25A-VQ4000 Series



## How to Order Valves

**Body**

0: Plug-in sub-plate

**Porting specifications**

Nil	Side ported
B	Bottom ported

**Port size**

Nil	Without sub-plate (For manifold)
02	Rc 1/4
03	Rc 3/8

\* Thread standard is the same as standard products.

**Plug-in** 25A-VQ4 1 0 1 - - - - - 1 - - - - -

**Plug lead** 25A-VQ4 2 5 1 - - - - - 1 - - - - -

**Series compatible with secondary batteries**

**Type of actuation**

1	2-position single
2	Rubber/2-position double
3	3-position closed center
4	3-position exhaust center
5	3-position pressure center
6*1	3-position double check

\*1 For double check type, refer to the **Web Catalog**.

**Body**

5: Plug lead sub-plate

**Seal type**

1	Rubber seal
---	-------------

**Function**

Nil*1	Standard type (0.95 W)
Y*2	Low wattage type (0.4 W)
R*3	External pilot

\*1 When the unit is energized continuously, refer to "Specific Product Precautions 1" on page 533 in the **Web Catalog** (VQ4000 series).  
\*2 Only DC is available with Y.  
\*3 External pilot specifications are the same as standard products. Combination of external pilot and perfect interface is not possible.  
\* When two or more symbols are specified, indicate them alphabetically.

**Enclosure**

Nil	Dustproof
W	Dust-tight/Water-jet-proof type (IP65)

**CE-compliant**

Nil	—
Q	CE-compliant

\* CE-compliant: For DC only.

**Manual override**

Nil: Non-locking push type (Tool required)

B: Slotted locking type (Tool required)

C: Locking type (Manual)

**Light/Surge voltage suppressor**

Nil	Yes
E	Without light, with surge voltage suppressor

**Electrical entry**

Grommet	G	Lead wire length 0.6 m
	H	Lead wire length 1.5 m

**Coil voltage**

1	100 VAC (50/60 Hz)
2	200 VAC (50/60 Hz)
3	110 VAC (50/60 Hz)
4	220 VAC (50/60 Hz)
5	24 VDC
6	12 VDC



## How to Order Sub-plates

**25A-VQ4000** - - - - -

**Series compatible with secondary batteries**

**Electrical entry**

P	Plug-in conduit terminal
S	Plug lead

**Enclosure**

Nil	Dustproof
W*1	Dust-tight/Water-jet-proof type

\*1 It is not necessary for plug lead type.

**CE-compliant**

Nil	—
Q	CE-compliant

**Porting specifications**

Nil	Side ported
B	Bottom ported*1

\*1 For bottom ported port size is Rc 1/4 only.  
\* Thread standard is the same as standard products.

**Port size**

02	Rc1/4
03	Rc3/8

\* The 25A- series specifications and dimensions are the same as those of the standard model. [Click here for details.](#)

# Plug-in Unit/Base Mounted F Kit (D-sub connector kit) 25A-VQ4000 Series



## How to Order Manifold

**25A – VV5Q 4 1 – 08 C8 F U 1 – [ ] – [ ]**

- Series compatible with secondary batteries**
- Series**

4	VQ4000
---	--------
- Manifold**

1	Plug-in unit
---	--------------
- Stations**

01	1 station
⋮	⋮
18	18 stations
- Cylinder port**

C6	With One-touch fitting for ø6
C8	With One-touch fitting for ø8
C10	With One-touch fitting for ø10
C12	With One-touch fitting for ø12
02	Rc 1/4
03	Rc 3/8
B	Bottom ported Rc 1/4
CM	Mixed

\* As a semi-standard specification, the maximum number of stations can be increased by special wiring specifications.
- CE-compliant**

Nil	—
Q	CE-compliant
- Option**

Symbol	Option
Nil	None
K*1	Special wiring specifications (Except double wiring)

\*1 Specify the wiring specifications on the manifold specification sheet.
- Cable (Length)**

0	Without cable
1	Cable length 1.5 m
2	Cable length 3 m
3	Cable length 5 m
- Connector entry direction**

D	D side entry
U	U side entry

## How to Order Valves

**25A – VQ 4 1 0 1 [ ] – 5 [ ] [ ] 1 – [ ]**

- Series compatible with secondary batteries**
- Series**

4	VQ4000
---	--------
- Type of actuation**

1	2-position single
2	2-position double
3	3-position closed center
4	3-position exhaust center
5	3-position pressure center
6	3-position double check
- Seal type**

1	Rubber seal
---	-------------
- Function**

Nil*1	Standard (0.95 W)
Y*2	Low wattage type (0.4 W)
R*3	External pilot

\*1 When the unit is energized continuously, refer to "Specific Product Precautions 1" on page 533 in the **Web Catalog** (VQ4000 series).  
\*2 Only DC is available with Y.  
\*3 External pilot specifications are the same as standard products. Combination of external pilot and perfect interface is not possible.  
\* When two or more symbols are specified, indicate them alphabetically.
- CE-compliant**

Nil	—
Q	CE-compliant

\* CE-compliant: For DC only.
- Manual override**

Nil	Non-locking push type (Tool required)
B	Locking type (Tool required)
C	Locking type (Manual)
- Light/Surge voltage suppressor**

Nil	Yes
E	Without light, with surge voltage suppressor
- Coil voltage**

1	100 VAC (50/60 Hz)
2	200 VAC (50/60 Hz)
3	110 VAC (50/60 Hz)
4	220 VAC (50/60 Hz)
5	24 VDC
6	12 VDC

\* The 25A- series specifications and dimensions are the same as those of the standard model.

[Click here for details.](#)

# Plug-in Unit/Base Mounted T Kit (Terminal block box kit) 25A-VQ4000 Series



## How to Order Manifold

**25A – VV5Q 4 1 – 08 C8 T O – [ ] – [ ]**

• Series compatible with secondary batteries

**Series**

4	VQ4000
---	--------

**Manifold**

1	Plug-in unit
---	--------------

**Stations**

03	3 stations
:	:
18	18 stations

\* 2 stations are used for mounting the terminal block box. The number of stations is the number of manifold valves plus 2 stations for the terminal block box. For 13 stations or more, specify the wiring specifications by means of the manifold specification sheet.

• **CE-compliant**

Nil	—
Q	CE-compliant

• **Option**

Symbol	Option
Nil	None
K*1	Special wiring specifications (Except double wiring, for 13 stations or more)
N*2	Name plate
W	IP65 enclosure

\*1 Specify the wiring specifications on the manifold specification sheet.  
\*2 Name plate is inlaid in the terminal block cover.  
\* When two or more symbols are specified, indicate them alphabetically. Example) -KM

• **Box mounting position**

O	U side mounting
D	D side mounting

• **Cylinder port**

C6	With One-touch fitting for ø6
C8	With One-touch fitting for ø8
C10	With One-touch fitting for ø10
C12	With One-touch fitting for ø12
02	Rc 1/4
03	Rc 3/8
B	Bottom ported Rc 1/4
CM	Mixed

\* As a semi-standard specification, the maximum number of stations can be increased by special wiring specifications.



## How to Order Valves

**25A – VQ 4 1 0 1 [ ] – 5 [ ] [ ] [ ] 1 – [ ]**

• Series compatible with secondary batteries

**Series**

4	VQ4000
---	--------

**Type of actuation**

1	2-position single
2	2-position double
3	3-position closed center
4	3-position exhaust center
5	3-position pressure center
6	3-position double check

**Seal type**

1	Rubber seal
---	-------------

**Function**

Nil*1	Standard (0.95 W)
Y*2	Low wattage type (0.4 W)
R*3	External pilot

\*1 When the unit is energized continuously, refer to "Specific Product Precautions 1" on page 533 in the **Web Catalog** (VQ4000 series).  
\*2 Only DC is available with Y.  
\*3 External pilot specifications are the same as standard products. Combination of external pilot and perfect interface is not possible.  
\* When two or more symbols are specified, indicate them alphabetically.

• **CE-compliant**

Nil	—
Q	CE-compliant

\* CE-compliant: For DC only.

• **Enclosure**

Nil	Dustproof
W	Dust-tight/Water-jet-proof type (IP65)

• **Manual override**

Nil	Non-locking push type (Tool required)
B	Locking type (Tool required)
C	Locking type (Manual)

• **Light/Surge voltage suppressor**

Nil	Yes
E	Without light, with surge voltage suppressor

• **Coil voltage**

1	100 VAC (50/60 Hz)
2	200 VAC (50/60 Hz)
3	110 VAC (50/60 Hz)
4	220 VAC (50/60 Hz)
5	24 VDC
6	12 VDC

\* The 25A- series specifications and dimensions are the same as those of the standard model.

[Click here for details.](#)

# Plug-in Unit/Base Mounted L Kit (Lead wire cable) 25A-VQ4000 Series



## How to Order Manifold

**25A – VV5Q 4 1 – 08 C8 L D – –**

- Series compatible with secondary batteries**
- Series**

4	VQ4000
---	--------
- Manifold**

1	Plug-in unit
---	--------------
- Stations**

01	1 station
⋮	⋮
16	16 stations
- Cylinder port**

C6	With One-touch fitting for ø6
C8	With One-touch fitting for ø8
C10	With One-touch fitting for ø10
C12	With One-touch fitting for ø12
02	Rc 1/4
03	Rc 3/8
B	Bottom ported Rc 1/4
CM	Mixed
- CE-compliant**

Nil	—
Q	CE-compliant
- Option**

Symbol	Option
Nil	None
W	IP65 enclosure
- Cable (Length)**

0	Cable length 0.6 m
1	Cable length 1.5 m
2	Cable length 3 m
- Connector locations**

D	D side entry
U	U side entry



## How to Order Valves

**25A – VQ 4 1 0 1 – 5 – – – 1 –**

- Series compatible with secondary batteries**
- Series**

4	VQ4000
---	--------
- Type of actuation**

1	2-position single
2	2-position double
3	3-position closed center
4	3-position exhaust center
5	3-position pressure center
6	3-position double check
- Seal type**

1	Rubber seal
---	-------------
- Function**

Nil*1	Standard (0.95 W)
Y*2	Low wattage type (0.4 W)
R*3	External pilot
- CE-compliant**

Nil	—
Q	CE-compliant

\* CE-compliant: For DC only.
- Enclosure**

Nil	Dustproof
W	Dust-tight/Water-jet-proof type (IP65)
- Manual override**

Nil	Non-locking push type (Tool required)
B	Locking type (Tool required)
C	Locking type (Manual)
- Light /Surge voltage suppressor**

Nil	Yes
E	Without light, with surge voltage suppressor
- Coil voltage**

1	100 VAC (50/60 Hz)
2	200 VAC (50/60 Hz)
3	110 VAC (50/60 Hz)
4	220 VAC (50/60 Hz)
5	24 VDC
6	12 VDC

\*1 When the unit is energized continuously, refer to "Specific Product Precautions 1" on page 533 in the **Web Catalog** (VQ4000 series).  
 \*2 Only DC is available with Y.  
 \*3 External pilot specifications are the same as standard products. Combination of external pilot and perfect interface is not possible.  
 \* When two or more symbols are specified, indicate them alphabetically.

\* The 25A- series specifications and dimensions are the same as those of the standard model. [Click here for details.](#)

# Plug-in Unit/Base Mounted S Kit (Serial transmission unit) 25A-VQ4000 Series

\* Refer to "SI Unit Part Nos." when ordering the CE-compliant SI unit.



## How to Order Manifold

**25A - VV5Q 4 1 - 08 C8 S D V - [ ] - [ ]**

• **Series compatible with secondary batteries**

• **Series**

4	VQ4000
---	--------

• **Manifold**

1	Plug-in unit
---	--------------

• **Stations**

03	3 stations
⋮	⋮
18	18 stations

\* 2 stations are used for mounting SI unit. The number of stations is the number of manifold valves plus 2 stations for SI unit. For 11 stations or more, specify the wiring specifications by means of the manifold specification sheet.

• **Cylinder ports**

C6	With One-touch fitting for ø6
C8	With One-touch fitting for ø8
C10	With One-touch fitting for ø10
C12	With One-touch fitting for ø12
02	Rc 1/4
03	Rc 3/8
B	Bottom ported Rc 1/4
CM	Mixed

• **CE-compliant**

Nil	—
Q	CE-compliant

• **Option**

Symbol	Option
Nil	None
K*1	Special wiring specifications (Except double wiring, for 11 stations or more)
W	IP65 enclosure

\*1 Specify the wiring specifications on the manifold specification sheet.  
\* When two or more symbols are specified, indicate them alphabetically. Example) -KW

• **SI unit**

0	Without SI unit
Q	DeviceNet™
V	CC-Link

• **SI unit mounting position**

Nil	U side mounting
D	D side mounting

## How to Order Valves

**25A - VQ 4 1 0 1 [ ] - 5 [ ] [ ] [ ] 1 - [ ]**

• **Series compatible with secondary batteries**

• **Series**

4	VQ4000
---	--------

• **Type of actuation**

1	2-position single
2	2-position double
3	3-position closed center
4	3-position exhaust center
5	3-position pressure center
6	3-position double check

• **Seal type**

1	Rubber seal
---	-------------

• **Function**

Nil*1	Standard (0.95 W)
Y*2	Low wattage type (0.4 W)
R*3	External pilot

\*1 When the unit is energized continuously, refer to "Specific Product Precautions 1" on page 533 in the **Web Catalog** (VQ4000 series).  
\*2 Only DC is available with Y.  
\*3 External pilot specifications are the same as standard products. Combination of external pilot and perfect interface is not possible.  
\* When two or more symbols are specified, indicate them alphabetically.

• **CE-compliant**

Nil	—
Q	CE-compliant

\* CE-compliant: For DC only.

• **Enclosure**

Nil	Dustproof
W	Dust-tight/Water-jet-proof type (IP65)

• **Manual override**

Nil	Non-locking push type (Tool required)
B	Locking type (Tool required)
C	Locking type (Manual)

• **Light /Surge voltage suppressor**

Nil	Yes
E	Without light, with surge voltage suppressor

• **Coil voltage**

5	24 VDC
---	--------

\* The 25A- series specifications and dimensions are the same as those of the standard model.

[Click here for details.](#)

# Plug Lead Unit/Base Mounted C Kit (Connector kit) 25A-VQ4000 Series



## How to Order Manifold

**25A - VV5Q 4 5 - 08 C8 C - W -**

- Series compatible with secondary batteries**
- Series**

4	VQ4000
---	--------
- Manifold**

5	Plug lead unit
---	----------------
- Stations**

01	1 station
⋮	⋮
16	16 stations
- Cylinder port**

C6	With One-touch fitting for $\phi 6$
C8	With One-touch fitting for $\phi 8$
C10	With One-touch fitting for $\phi 10$
C12	With One-touch fitting for $\phi 12$
02	Rc 1/4
03	Rc 3/8
B	Bottom ported Rc 1/4
CM	Mixed
- Kit type**

<b>C</b>	kit (Connector)
----------	-----------------
- CE-compliant**

Nil	—
Q	CE-compliant
- Option**

Symbol	Option
Nil	None
W	IP65 enclosure

**Refer to the Web Catalog for wiring specifications.**

## How to Order Valves

**25A - VQ 4 1 5 1 - 5 G -**

- Series compatible with secondary batteries**
- Series**

4	VQ4000
---	--------
- Type of actuation**

1	2-position single
2	2-position double
3	3-position closed center
4	3-position exhaust center
5	3-position pressure center
6	3-position double check
- Seal type**

1	Rubber seal
---	-------------
- Function**

Nil*1	Standard (0.95 W)
Y*2	Low wattage type (0.4 W)
R*3	External pilot
- Enclosure**

Nil	Dustproof
W	Dust-tight/Water-jet-proof type (IP65)
- Manual override**

Nil:	Non-locking push type (Tool required)
B:	Locking type (Tool required)
C:	Locking type (Manual)
- Light/Surge voltage suppressor**

Nil	Yes
E	Without light, with surge voltage suppressor
- Electrical entry**

G	Lead wire length 0.6 m
H	Lead wire length 1.5 m
- Coil voltage**

1	100 VAC (50/60 Hz)	4	220 VAC (50/60 Hz)
2	200 VAC (50/60 Hz)	5	24 VDC
3	110 VAC (50/60 Hz)	6	12 VDC

\* CE-compliant: For DC only.

\*1 When the unit is energized continuously, refer to "Specific Product Precautions 1" on page 533 in the Web Catalog (VQ4000 series).  
 \*2 Only DC is available with Y.  
 \*3 External pilot specifications are the same as standard products. Combination of external pilot and perfect interface is not possible.  
 \* When two or more symbols are specified, indicate them alphabetically.

\* The 25A- series specifications and dimensions are the same as those of the standard model. [Click here for details.](#)

# 25A-VQ4000 Series

## Manifold Options

### Blanking plate assembly

- 25A-VVQ4000-10A-1 (Plug-in type)
- 25A-VVQ4000-10A-5 (Plug lead type)

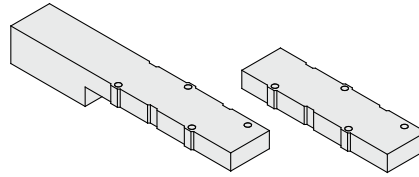

It is used by attaching on the manifold block for being prepared for removing a valve for maintenance reasons or planning to mount a spare valve, etc.

\* The 25A- series specifications and dimensions are the same as those of the standard model.

[Click here for details.](#)

### SI Unit Part Nos.

Description	SI unit part no.	Note
EX124 SI unit	<b>EX124D-SMJ1-X220</b>	CC-Link/D side mounting
	<b>EX124D-SDN1-X220</b>	DeviceNet™/D side mounting
	<b>EX124U-SMJ1-X220</b>	CC-Link/U side mounting
	<b>EX124U-SDN1-X220</b>	DeviceNet™/U side mounting

### One-touch Fittings Part Nos.

		Port size	One-touch fittings part no.
Cylinder port	Metric size	ø6 One-touch fitting (Straight type)	<b>90-VVQ4000-50B-C6</b>
		ø8 One-touch fitting (Straight type)	<b>90-VVQ4000-50B-C8</b>
		ø10 One-touch fitting (Straight type)	<b>90-VVQ4000-50B-C10</b>
		ø12 One-touch fitting (Straight type)	<b>90-VVQ4000-50B-C12</b>

# Plug-in Unit

# 25A-SQ2000 Series



## How to Order Manifold

25A – SS5Q23 – 08 FD2 – D – – –

Series compatible with secondary batteries

### Stations

01	1 station
⋮	⋮
16*1	16 stations

\*1 The maximum number of stations depends on the type of electrical entries.

### Manifold mounting

D	DIN rail mounting
E	Direct mounting

### Option

Nil	None
02 to 16*1	DIN rail length specified
B*2	Back pressure check valve
K*3	Special wiring specifications (Except double wiring)
N	With name plate (Side ported only)
R	External pilot specifications
S	Built-in silencer, direct exhaust

- \*1 Specify DIN rail length with "D□" at the end. (Enter the number of stations inside □.) The number of stations that may be displayed is longer than the manifold number of stations. Example: -D09
- \*2 When "B" is selected, a back pressure check valve is included in all stations of the manifold. If the back pressure check valve is used only for the station that need it, then specify the station location in the manifold specification. ("B" is not necessary)
- \*3 Specify "K" for wiring specification for cases below. (Except L kit)
  - All single wiring
  - Single and double mixed wiring
  - When there are stations which do not require wiring (e.g. single SUP spacer)
 Specify the wiring specification in the manifold specification so that the number of solenoids is the maximum number of solenoids or less. (Standard wiring specification is double wiring)
- \* For specifying two or more options, enter them alphabetically. Example: -BKN

### CE-compliant

Nil	—
Q	CE-compliant

### 1(P), 3(R) port size

Nil	1(P), 3(R) port One-touch fittings for ø10
00T	1(P), 3(R) port One-touch fittings for ø3/8"

### Electrical entry

Kit type	Lead wire connector location	Cable specifications	Station	Max. number of stations for special wiring specifications	Max. number of solenoids *1
<b>F kit</b> The electric parts are made of copper. Mounting screw: Stainless steel D-sub connector kit	D side	FD0	D-sub connector (25P) kit, without cable	1 to 12 stations	16 stations
		FD1	D-sub connector (25P) kit, with 1.5 m cable		
		FD2	D-sub connector (25P) kit, with 3.0 m cable		
		FD3	D-sub connector (25P) kit, with 5.0 m cable		
<b>T kit</b> Terminal block box kit	TD0	Terminal block box kit	1 to 10 stations	16 stations	16
<b>L kit</b> Mounting screw: Stainless steel Lead wire kit	LD0	Lead wire kit with 0.6 m cable	1 to 12 stations	—	—
	LU0				
	LD1	Lead wire kit with 1.5 m cable			
	LU1				
	LD2	Lead wire kit with 3.0 m cable			
	LU2				
<b>S kit</b> The electric parts are made of copper. Mounting screw: Stainless steel Serial transmission kit EX140 integrated-type (for output) serial transmission system*2	SDQ	DeviceNet™	1 to 8 stations	16 stations	16
	SDV	CC-Link	1 to 8 stations	16 stations	16

\*1 The maximum number of stations should not be more than the maximum number of solenoids. (The number of solenoids are counted as: 1 for single solenoids and 2 for type 3P and 4P double solenoids.)

\*2 Refer to the **Web Catalog** for the details of EX140 integrated-type (for output) serial transmission system. Refer to "SI unit part nos." below when ordering the CE-compliant SI unit.

### SI unit part nos.

Symbol	Protocol type	SI unit part no.	Page
SDQ	DeviceNet™	EX140-SDN1-X220	p. 60
SDV	CC-Link	EX140-SMJ1-X220	

### Blanking plate assembly

25A-SSQ2000-10A-3

\* The 25A-series specifications and dimensions are the same as those of the standard model.

[Click here for details.](#)



## How to Order Valves

25A-SQ2 **1** **3** **1** **5** **1** **C6**

Series compatible with secondary batteries

### Type of actuation

1	2-position single
2	2-position double (Double solenoid)*1
3	3-position closed center
4	3-position exhaust center
5	3-position pressure center
A	4-position dual 3-port valve (N.C./N.C.)
B	4-position dual 3-port valve (N.O./N.O.)
C	4-position dual 3-port valve (N.C./N.O.)

\*1 For double solenoid specification, the function symbol below is "D."

### Seal type

1	Rubber seal
---	-------------

### Function

Nil	Standard (0.4 W DC)
B	Quick response type (0.95 W)
D*1	2-position double (Double solenoid specifications)
N*2	Negative common
R*3	External pilot specifications

\*1 "D" is specified for 2-position double.  
 \*2 For L kit, when the manifold specifies negative common, the valve common should also be negative.  
 \*3 Except dual 3-port valves.  
 \* When two or more symbols are specified, indicate them alphabetically.

### CE-compliant

Nil	—
Q	CE-compliant

### With/Without manifold block

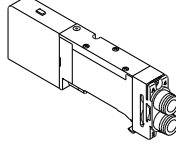
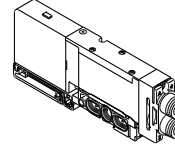
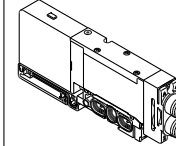
Nil	M	MB
Without manifold block	With manifold block	With manifold block, built-in back pressure check valve
		
	* Lead wire is not included.	* Lead wire is not included.
<ul style="list-style-type: none"> <li>When ordering with manifolds</li> <li>When only valves are required.</li> </ul>	For adding stations	

### Port plug mounting port

Nil	None
A	Port 4(A)
B	Port 2(B)

### Cylinder port

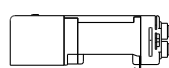
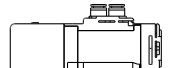
C4	One-touch fittings for ø4	Side ported	
C6	One-touch fittings for ø6		
C8	One-touch fittings for ø8		
L4	One-touch fittings for ø4	Top ported *1	
L6	One-touch fittings for ø6		
L8	One-touch fittings for ø8		

\*1 Can be changed to side ported configuration.

### Manual override

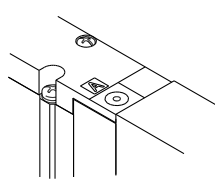
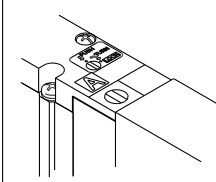
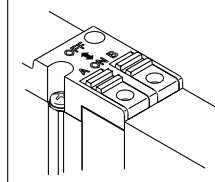
Nil	B	D
Non-locking push type (Tool required)	Locking type (Tool required)	Slide locking type (Manual type) * Only side ported type applicable
		

### Coil voltage

5	24 VDC
6	12 VDC

\* Light/Surge voltage suppressor is built-in.  
 \* S kit: 24 VDC only

\* The 25A- series specifications and dimensions are the same as those of the standard model.

[Click here for details.](#)



## How to Order Valves

25A—SQ2 **1** 4 **1**   — **5** **L**   **1** — **C6** —   —   —  

• Series compatible with secondary batteries

### Type of actuation

1	2-position single
2	2-position double (Double solenoid)*1
3	3-position closed center
4	3-position exhaust center
5	3-position pressure center
A	4-position dual 3-port valve (N.C./N.C.)
B	4-position dual 3-port valve (N.O./N.O.)
C	4-position dual 3-port valve (N.C./N.O.)

\*1 For double solenoid specification, the function symbol below is "D."

### Seal type

1	Rubber seal
---	-------------

### Function

Nil	Standard (0.4 W DC)
B	Quick response type (0.95 W)
D*1	2-position double (Double solenoid specifications)
N	Negative COM
R*2	External pilot specifications

\*1 "D" is specified for 2-position double.

\*2 Except dual 3-port valves.

\* When two or more symbols are specified, indicate them alphabetically.

### Coil voltage

5	24 VDC
6	12 VDC

\* Light/Surge voltage suppressor is built-in.

### CE-compliant

Nil	—
Q	CE-compliant

### With/Without manifold block

Nil	M	MB
Without manifold block	With manifold block	With manifold block, built-in back pressure check valve
	* Lead wire is not included.	* Lead wire is not included.
• When ordering with manifolds • When only valves are required.		
For adding stations		

### Port plug mounting port

Nil	None
A	Port 4(A)
B	Port 2(B)

### Cylinder port

C4	One-touch fitting for ø4	Side ported	
C6	One-touch fitting for ø6		
C8	One-touch fitting for ø8	Top ported *1	
L4	One-touch fitting for ø4		
L6	One-touch fitting for ø6		
L8	One-touch fitting for ø8		

\*1 Can be changed to side ported configuration.

### Manual override

Nil	B	D
Non-locking push type (Tool required)	Locking type (Tool required)	Side locking type (Manual type) * Only side ported type applicable

### Electrical entry

L	LO
Plug connector type with 300 mm lead wire	Plug connector type without connector
	For F, P, J kit manifolds*1

\*1 Indicate "LO" when ordering centralized wiring type manifolds, F, P, and J kits, since the lead wire will be attached to the manifold side.

\* The 25A- series specifications and dimensions are the same as those of the standard model. [Click here for details.](#)

## SI Unit Part Nos.

Description	SI unit part no.	Note
EX140 SI unit	<b>EX140-SMJ1-X220</b>	CC-Link
	<b>EX140-SDN1-X220</b>	DeviceNet™

## One-touch Fittings Part Nos.

Port size			One-touch fittings part no.
Cylinder port	Metric size	ø4 One-touch fitting (Straight type)	<b>90-VVQ1000-51A-C4</b>
		ø6 One-touch fitting (Straight type)	<b>90-VVQ1000-51A-C6</b>
		ø8 One-touch fitting (Straight type)	<b>90-VVQ1000-51A-C8</b>
1 (P), 3 (R) port	Metric size	ø10 One-touch fitting (Straight type)	<b>90-VVQ2000-51A-C10</b>

Directional  
Control Valves

Air Cylinders

Related  
Products

Rotary  
Actuators

Air Grippers

Vacuum  
Equipment

Air Preparation  
Equipment

Clean  
Air Filters

Modular F.R.L./Pressure  
Control Equipment

Fittings/Flow  
Control Equipment

Detection  
Switches

Fluid Control  
Equipment

Electric  
Actuators

Auto  
Switches

# 5-Port Solenoid Valve

## 25A-VQZ1000 Series

### Single Unit



#### How to Order Valves

**25A-VQZ 1 1 5 1**    - **5 M**    1 - **01** -   

• Series compatible with secondary batteries

• Series

1	VQZ1000 body width 10 mm
---	--------------------------

• Type of actuation

1	2-position single
2	2-position double
3	3-position closed center
4	3-position exhaust center
5	3-position pressure center
8	3-port for mixture mounting N.C.
9	3-port for mixture mounting N.O.

• Body type

5	Base mounted
---	--------------

• Seal type

1	Rubber seal
---	-------------

• Function

Symbol	Specifications	DC	AC
Nil	Standard	(0.35 W) ○	○
B	High speed response type	(0.9 W) ○	—
R	External pilot type	○	○
BR	High speed response/External pilot type	(0.9 W) ○	—

• CE-compliant

Nil	—
Q	CE-compliant

\* DC-type only.



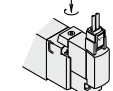

• Port size

Symbol	Port size
Nil	Without sub-plate
01	Rc1/8

• Manual override

<p><b>Nil:</b> Non-locking push type (Tool required)</p> 	<p><b>B:</b> Locking type (Tool required)</p> 
--	---

• Electrical entry

G: Grommet (DC specification)	L: L-type plug connector with lead wire	LO: L-type plug connector without connector	M: M-type plug connector with lead wire	MO: M-type plug connector without connector
	With light/surge voltage suppressor	With light/surge voltage suppressor	With light/surge voltage suppressor	With light/surge voltage suppressor
				

• Coil voltage

1	100 VAC (50/60 Hz)
2	200 VAC (50/60 Hz)
3	110 VAC [115 VAC] (50/60 Hz)
4	220 VAC [230 VAC] (50/60 Hz)
5	24 VDC
6	12 VDC

### ⚠ Caution

Use standard (DC) specification for continuous duty.

\* The 25A- series specifications and dimensions are the same as those of the standard model.

[Click here for details.](#)

Base Mounted  
Plug Lead Unit

# 5-Port Solenoid Valve

## 25A-VQZ1000 Series

### Manifold Connector Kit



#### How to Order Manifold

**25A-VV5QZ 1 5-08 C6 C-R-**

Series compatible with secondary batteries

**Series**  
1 VQZ1000

**Manifold type**  
5 Base mounted

**Stations**  
02 2 stations  
: :  
20 20 stations

**Port size [4(A), 2(B) port]**

Symbol	Port size
C4	ø4 One-touch fitting
C6	ø6 One-touch fitting
M5	M5 thread
CM*1	Mixture of port sizes

\*1 Specify port mixture/with port plug by the manifold specification sheet. Port mixture and port plug are available only for One-touch fitting type.

**CE-compliant**

Nil	—
Q	CE-compliant

**Option**

Nil	None
R	External pilot type

**Kit type**  
C Connector

#### How to Order Valves

**25A-VQZ 1 1 5 1 - 5 M 1 -**

Series compatible with secondary batteries

**Series**  
1 VQZ1000 body width 10 mm

**Type of actuation**

1	2-position single
2	2-position double
3	3-position closed center
4	3-position exhaust center
5	3-position pressure center
8	3-port for mixture mounting N.C.
9	3-port for mixture mounting N.O.

**Body type**  
5 Base mounted

**Seal type**  
1 Rubber seal

**Function**

Symbol	Specifications	DC (0.35 W)	AC (0.9 W)
Nil	Standard	○	○
B	High speed response type	○	—
R	External pilot type	○	○
BR	High speed response/ External pilot type	○	—

**CE-compliant**

Nil	—
Q	CE-compliant

\* DC-type only.

**Manual override**

Nil	Non-locking push type (Tool required)
B	Locking type (Tool required)

**Electrical entry**

Symbol	Electrical entry	Light/surge voltage suppressor
G	Grommet (DC specification)	None
L	L-type plug connector with lead wire	Yes
LO	L-type plug connector without connector	
M	M-type plug connector with lead wire	
MO	M-type plug connector without connector	

**Coil voltage**

1	100 VAC (50/60 Hz)
2	200 VAC (50/60 Hz)
3	110 VAC [115 VAC] (50/60 Hz)
4	220 VAC [230 VAC] (50/60 Hz)
5	24 VDC
6	12 VDC

**Caution**  
Use standard (DC) specification for continuous duty.

\* The 25A- series specifications and dimensions are the same as those of the standard model.

[Click here for details.](#)

Body Ported  
Plug Lead Unit

# 5-Port Solenoid Valve

## 25A-VQZ1000 Series

### Single Unit



#### How to Order Valves

**25A-VQZ 1 1 2 1** [ ] - **5 M** [ ] 1 - **C6** - [ ] - [ ]

• **Series compatible with secondary batteries**

• **Series**

1	VQZ1000 body width 10 mm
---	--------------------------

• **Type of actuation**

1	2-position single
2	2-position double
3	3-position closed center
4	3-position exhaust center
5	3-position pressure center
8	3-port for mixture mounting N.C.
9	3-port for mixture mounting N.O.

\* 3-port for mixture mounting is only available for port size C4 or C6.

• **Body type**

2	Body ported
---	-------------

• **Seal type**

1	Rubber seal
---	-------------

• **Function**

Symbol	Specifications	DC	AC
Nil	Standard	(0.35 W) ○	○
B	High speed response type	(0.9 W) ○	—

• **Coil voltage**

1	100 VAC (50/60 Hz)
2	200 VAC (50/60 Hz)
3	110 VAC [115 VAC] (50/60 Hz)
4	220 VAC [230 VAC] (50/60 Hz)
5	24 VDC
6	12 VDC

• **CE-compliant**

Nil	—
Q	CE-compliant

\* DC-type only.

• **Option**

Nil: None  
F: With bracket (2-position single type only)

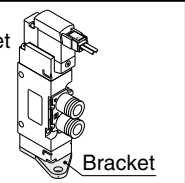

• **Port size [4(A), 2(B) port]**

Symbol	Port size
C4	ø4 One-touch fitting
C6	ø6 One-touch fitting
M5	M5 thread

• **Manual override**

<p>Nil: Non-locking push type (Tool required)</p>	<p>B: Locking type (Tool required)</p>
---	--

• **Electrical entry**

G: Grommet (DC specification)	L: L-type plug connector with lead wire	LO: L-type plug connector without connector	M: M-type plug connector with lead wire	MO: M-type plug connector without connector
	With light/surge voltage suppressor	With light/surge voltage suppressor	With light/surge voltage suppressor	With light/surge voltage suppressor

### ⚠ Caution

Use standard (DC) specification for continuous duty.

\* The 25A- series specifications and dimensions are the same as those of the standard model.

[Click here for details.](#)

Body Ported  
Plug Lead Unit

# 5-Port Solenoid Valve

## 25A-VQZ1000 Series

### Manifold Connector Kit



#### How to Order Manifold

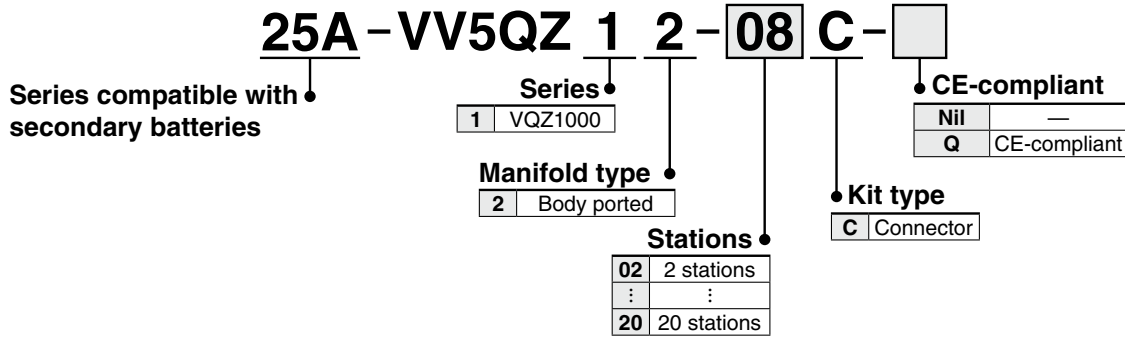

#### How to Order Valves

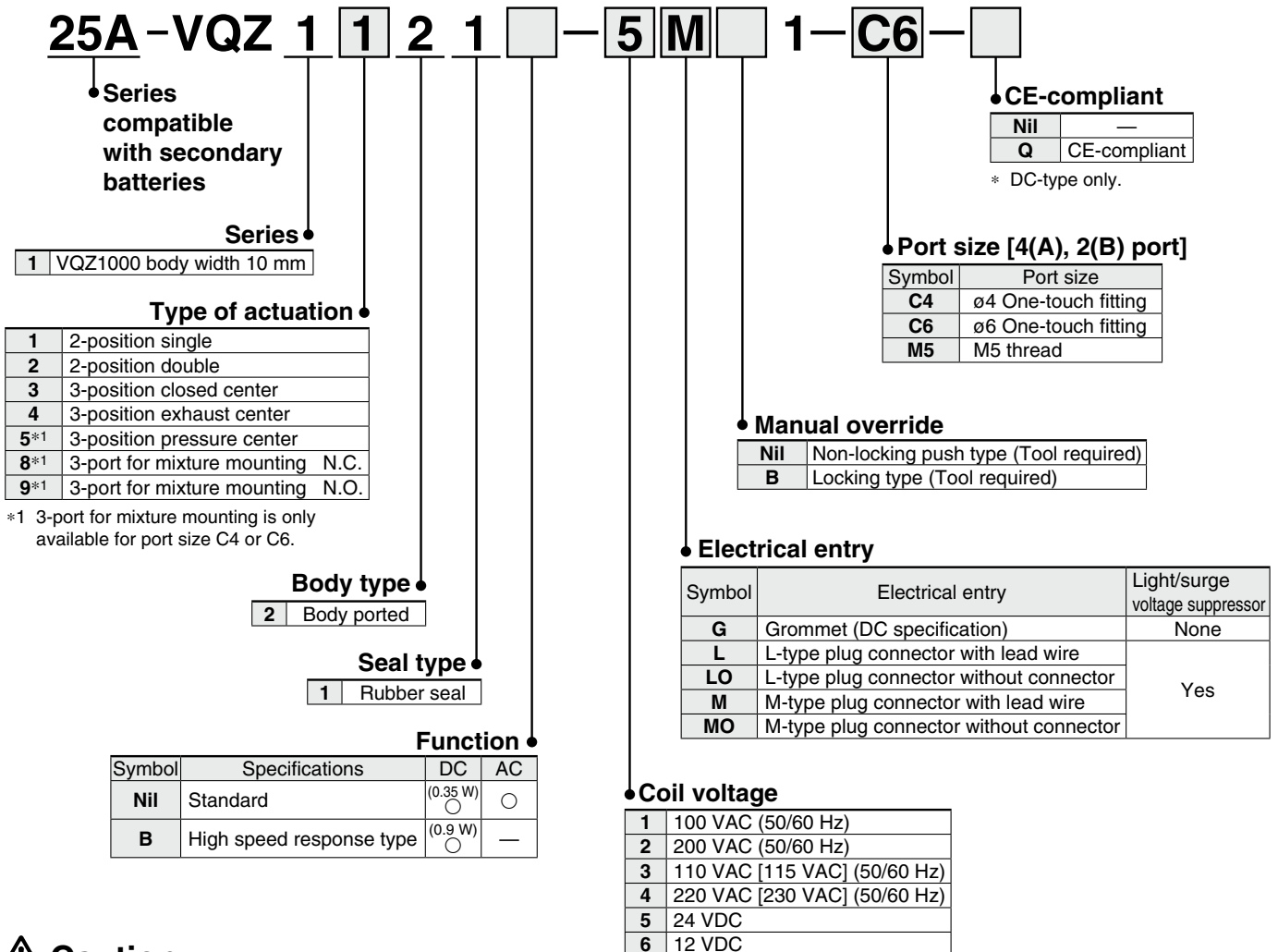

**Caution**  
Use standard (DC) specification for continuous duty.

\* The 25A- series specifications and dimensions are the same as those of the standard model.

[Click here for details.](#)

Directional Control Valves  
Air Cylinders  
Related Products  
Rotary Actuators  
Air Grippers  
Vacuum Equipment  
Air Preparation Equipment  
Clean Air Filters  
Modular FRL/Pressure Control Equipment  
Fittings/Flow Control Equipment  
Detection Switches  
Fluid Control Equipment  
Electric Actuators  
Auto Switches

# Plug-in Unit Base Mounted

# 25A-VQ1000/2000 Series Double check block (Separated)

## How to Order

Double check block

**25A-VQ1000-FPG-C4M5-F**

• Series compatible with secondary batteries

• IN side port size

M5	M5 thread
C3	ø3.2 One-touch fitting
C4	ø4 One-touch fitting
C6	ø6 One-touch fitting

• OUT side port size

M5	M5 thread
C3	ø3.2 One-touch fitting
C4	ø4 One-touch fitting
C6	ø6 One-touch fitting

• Option

Nil	None
F	With bracket
D	DIN rail mounting (For manifold)
N	Name plate

\* When two or more symbols are specified, indicate them alphabetically.  
Example) -DN

Manifold (DIN rail mounting)

**25A-VVQ1000-FPG-06**

• Series compatible with secondary batteries

When ordering a double check block, order the DIN rail mounting [-D].

<Ordering example>

25A-VVQ1000-FPG-06...6-station manifold

\* 25A-VQ1000-FPG-C4M5-D;  
3 sets } Double check block  
\* 25A-VQ1000-FPG-C6M5-D;  
3 sets }

• Stations

01	1 station
⋮	⋮
16	16 stations

Bracket Assembly

Part no.	Tightening torque
25A-VQ1000-FPG-FB	0.22 to 0.25 N·m

Double check block

**25A-VQ2000-FPG-0101-F**

• Series compatible with secondary batteries

• IN side port size

01	Rc 1/8
02	Rc 1/4
C6	ø6 One-touch fitting
C8	ø8 One-touch fitting

• OUT side port size

01	Rc 1/8
02	Rc 1/4
C6	ø6 One-touch fitting
C8	ø8 One-touch fitting

• Option

Nil	None
D	DIN rail mounting (For manifold)
F	With bracket
N	Name plate

\* When two or more symbols are specified, indicate them alphabetically.  
Example) -DN

Manifold (DIN rail mounting)

**25A-VVQ2000-FPG-06**

• Series compatible with secondary batteries

When ordering a double check block, order the DIN rail mounting [-D].

<Ordering Example>

25A-VVQ2000-FPG-06...6-station manifold

\* 25A-VQ2000-FPG-C6C6-D;  
3 sets } Double check block  
\* 25A-VQ2000-FPG-C8C8-D;  
3 sets }

• Stations

01	1 station
⋮	⋮
16	16 stations

Bracket Assembly

Part no.	Tightening torque
25A-VQ2000-FPG-FB	0.8 to 1.0 N·m

\* The 25A- series specifications and dimensions are the same as those of the standard model. [Click here for details.](#)

# Rubber Seal

## 3-Port/Pilot Poppet Type

# 25A-VP342/542/742 Series

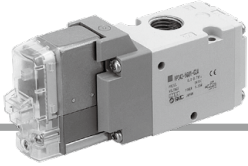

### How to Order



\* Only DIN and conduit terminal types are available for AC mode. Refer to the electrical entry for details.

Body ported **25A-VP 3 4 2** **5 D** **1-01** **A**

Series compatible with secondary batteries

#### Series

3	VP300
5	VP500
7	VP700

#### Pilot type

Nil	Internal pilot
R	External pilot

#### Pressure specification

Nil	Standard (0.7 MPa)
K	High pressure type (1.0 MPa)

#### Coil specification

Nil	Standard
T	With power saving circuit (DC only)

- \* Be sure to select the power saving circuit type when it is continuously energized for a long time.
- \* "T" type is only available for DC mode. When "T" is selected, only "Z" type of light/surge voltage suppressor is available.

#### Rated voltage

DC		AC (50/60 Hz)	
5	24 VDC	1	100 VAC
6	12 VDC	2	200 VAC
		3	110 VAC [115 VAC]
		4	220 VAC [230 VAC]
		7	240 VAC
		B	24 VAC

#### Electrical entry

	DIN terminal [IP65 compatible]	DIN (EN175301-803) terminal [IP65 compatible]	Conduit terminal [IP65 compatible]
	D: With connector	Y: With connector	T: Conduit terminal
CE-compliant	DC AC	CE CE	CE CE

#### Thread type

Nil	Rc
F	G
N	NPT
T	NPTF

#### Type of actuation

A	N.C. (Normally closed)
B	N.O. (Normally open)

#### Bracket

Nil	Without bracket
F	With bracket

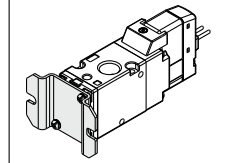

#### Port size

Symbol	Port size	VP300	VP500	VP700
01	1/8	○	—	—
02	1/4	○	○	—
03	3/8	—	○	○
04	1/2	—	—	○

#### Manual override

Nil: Non-locking push type	D: Push-turn locking slotted type	E: Push-turn locking lever type

#### Light/surge voltage suppressor

		DC	AC
Nil	Without light/surge voltage suppressor	○	○
S	With surge voltage suppressor	○	—*1
Z	With light/surge voltage suppressor	○	○
R	With surge voltage suppressor (Non-polar)	○	—
U	With light/surge voltage suppressor (Non-polar)	○	—

\*1 There is no "S" type for AC mode, since a rectifier prevents surge voltage generation.

\* The 25A- series specifications and dimensions are the same as those of the standard model.

[Click here for details.](#)

# Rubber Seal

## 3-Port/Pilot Poppet Type

# 25A-VP344/544/744 Series

### How to Order



\* Only DIN and conduit terminal types are available for AC mode. Refer to the electrical entry for details.

Base mounted **25A-VP** **3** **4** **4** **□** **□** **□** - **5** **D** **□** **□** **1-01** **□** **A**

Series compatible with secondary batteries

#### Series

3	VP300
5	VP500
7	VP700

#### Pilot type

Nil	Internal pilot
R	External pilot

#### Pressure specifications

Nil	Standard (0.7 MPa)
K	High pressure type (1.0 MPa)

#### Coil specifications

Nil	Standard
T	With power saving circuit (DC only)

\* Be sure to select the power saving circuit type when it is continuously energized for a long time.  
\* "T" type is only available for DC mode. When "T" is selected, only "Z" type of light/surge voltage suppressor is available.

#### Rated voltage

DC		AC (50/60 Hz)	
5	24 VDC	1	100 VAC
6	12 VDC	2	200 VAC
		3	110 VAC [115 VAC]
		4	220 VAC [230 VAC]
		7	240 VAC
		B	24 VAC

#### Thread type

Nil	Rc
F	G
N	NPT
T	NPTF

#### Type of actuation

A	N.C. (Normally closed)
B	N.O. (Normally open)

#### Port size (Sub-plate)

Symbol	Port size	VP300	VP500	VP700
Nil	Without sub-plate*1			
01	1/8	○	—	—
02	1/4	○	○	—
03	3/8	—	○	○
04	1/2	—	—	○

\*1 With a gasket and two mounting bolts.

#### Electrical entry

	DIN terminal	DIN (EN175301-803) terminal	Conduit terminal
	[IP65 compatible]	[IP65 compatible]	[IP65 compatible]
	D: With connector	Y: With connector	T: Conduit terminal
CE-compliant	DC AC	CE CE	CE CE

#### Manual override

Nil: Non-locking push type	D: Push-turn locking slotted type	E: Push-turn locking lever type

#### Light/surge voltage suppressor

		DC	AC
Nil	Without light/surge voltage suppressor	○	○
S	With surge voltage suppressor	○	—*1
Z	With light/surge voltage suppressor	○	○
R	With surge voltage suppressor (Non-polar)	○	—
U	With light/surge voltage suppressor (Non-polar)	○	—

\*1 There is no "S" type for AC mode, since a rectifier prevents surge voltage generation.

\* The 25A- series specifications and dimensions are the same as those of the standard model.

[Click here for details.](#)

# 3-Port Solenoid Valve/Residual Pressure Release Valve with Detection of Main Valve Position

## 25A-VP500/700-X536, X538, X555

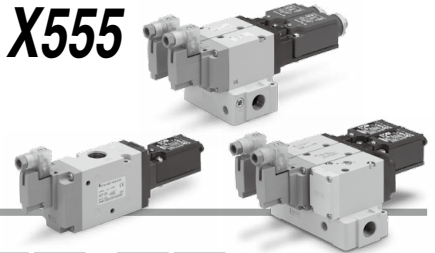

### How to Order

Residual pressure release valve

25A-VP 5 4 2 R - 5 D Z 1 - 03 [ ] - M [ ] - X536

Dual residual pressure release valve

25A-VP 5 4 4 R - 5 D Z 1 - 03 [ ] - M A - X538

Dual residual pressure release valve with soft start-up function

25A-VP 5 4 4 [ ] - 5 D Z 1 - 03 [ ] - M [ ] [ ] - X555

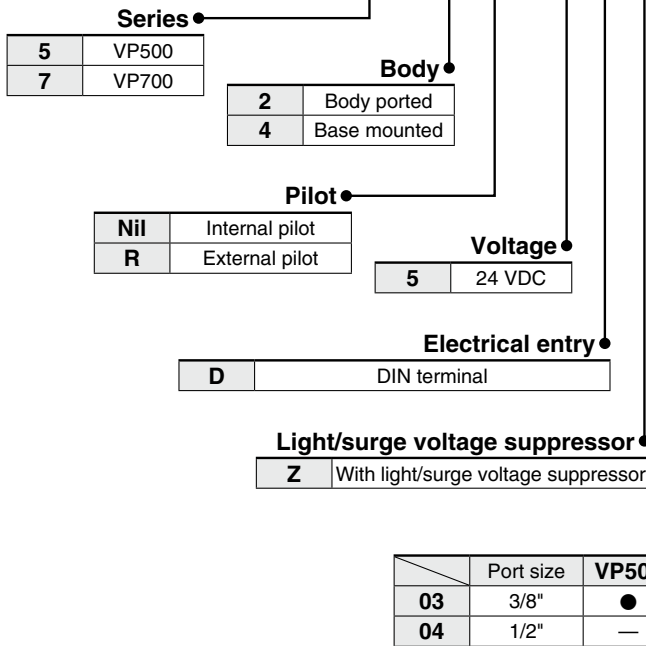

**Thread**

Nil	Rc
F	G
N	NPT

**Safety limit switch/Wiring**

Nil	G1/2 (Made by OMRON)
M	M12 connector (Made by OMRON)
S1	M12 connector (Made by Rockwell Automation)

**With check valve (Only external pilot)**

	Check valve	Applicable tube O.D.	Thread		
			Rc	G	NPT
Nil	None	—	●	●	●
A	Yes	ø6	●	—	—
B		ø1/4"	—	—	●

**Throttle**

Nil	Variable throttle
10	ø1 fixed orifice
15	ø1.5 fixed orifice
20 <sup>*1</sup>	ø2 fixed orifice

**Internal Pilot Type**

**Caution**

Valve may not operate properly when air supply to P port is not adequate and the supply pressure to the valve is lower than 0.25 MPa, the minimum operating pressure. Be careful with insufficient supply pressure.

**Piping for External Pilot Type**

**Caution**

The product may not operate when the external pilot pressure is insufficient due to simultaneous operation or restricted air piping. In this case, use the check valve (AKH series) with the external pilot port, change the piping size or adjust the set pressure to provide a constant pressure of 0.25 MPa or more.

\* For internal pilot, the symbol is nil.

\*1 VP700 only

\* The 25A- series specifications and dimensions are the same as those of the standard model.

[Click here for details.](#)

# 3-Port Solenoid Valve Direct Operated Poppet Type 25A-VT317 Series Rubber Seal



\* CE-compliant: For DIN terminal type.

## How to Order

25A-V T 317 [ ] - 1 G [ ] - 02 [ ] - [ ]

### Body type

T	Body ported
O	Manifold

Series compatible with secondary batteries

### Valve option

Nil	Standard
E*1	Continuous duty type
V*1	For vacuum

\*1 Semi-standard

### Rated voltage

1	100 VAC (50/60 Hz)
2	200 VAC (50/60 Hz)
3*1	110 VAC (50/60 Hz)
4*1	220 VAC (50/60 Hz)
5	24 VDC
6*1	12 VDC
7*1	240 VAC (50/60 Hz)

\*1 Semi-standard

\* Applicable only for DIN terminal type.

### Thread type

Nil	Rc
F	G
N	NPT
T	NPTF

### CE-compliant

Nil	—
Q	CE-compliant*1

\*1 Applicable only for DIN terminal type.

### Port size

Nil	Without port (For manifold)
02	1/4 (8A)

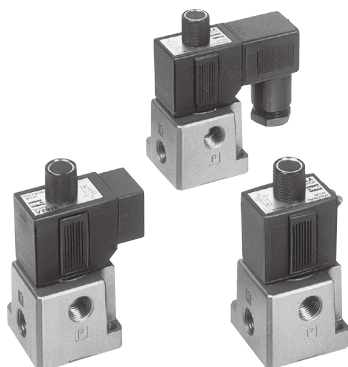

### Electrical entry

		CE-compliant
G	Grommet, 300 mm lead wire	—
H	Grommet, 600 mm lead wire	—
C	Conduit	—
D	DIN terminal	●

### Light/Surge voltage suppressor

Electrical entry Symbol	CE-compliant				
	G	H	C	D	D Only
Nil	—	—	—	—	●
S	●*1	●*1	●*1	●	●
Z	—	—	—	●	●

S: With surge voltage suppressor

\*1 Refer to the figure below.

Z: With light/surge voltage suppressor

Surge voltage suppressor mounting part (For "G")

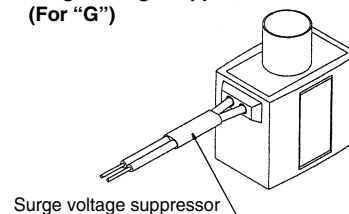

## Manifold

Model	Applicable manifold type	Accessory
VO317(-Q)	Common or individual exhaust	O-ring (KA00066, 4 pcs.)*1 Bolts (XT012-25C#1, 2 pcs.)

\*1 It is not applied to "Continuous duty type." Refer to the accessories in the **Web Catalog**.

\* The 25A- series specifications and dimensions are the same as those of the standard model.

[Click here for details.](#)

# 3-Port Solenoid Valve Direct Operated Poppet Type **25A-VG342 Series** Rubber Seal

## Low power consumption

4.8 W DC (Standard type)  
2 W DC (Energy-saving type)

## No lubrication required

## Possible to use in vacuum or under low pressures

External pilot  
Vacuum: Up to -101.2 kPa  
Low pressure: 0 to 0.2 MPa

## Changeable actuation:

N.C., N.O., or external pilot

Can be used as a selector or divider valve (External pilot)



## How to Order

**25A-VG342** [ ] - **5** **D** [ ] - **04** [ ] **A** - [ ]

Series compatible with secondary batteries

### Valve option

Nil	Internal pilot
R	External pilot

### Rated voltage

5	24 VDC
6*1	12 VDC

\*1 Semi-standard

### Electrical entry

D	DIN terminal
---	--------------

### Light/Surge voltage suppressor

Nil	None
z	With light/surge voltage suppressor (Except grommet type)

### Pilot valve option

Nil	Standard type
Y*1	Energy-saving type (DC only)
E*1	Continuous duty type

\*1 Semi-standard

### Passage symbol

Nil	External pilot
A	N.C. (Normally closed)
B	N.O. (Normally open)

### Thread type

Nil	Rc
-----	----

### Port size

04	1/2
06	3/4
10	1

\* The 25A- series specifications and dimensions are the same as those of the standard model.

[Click here for details.](#)

# 5-Port Air Operated Valve

# 25A-SYA5000/7000 Series

## How to Order

**Body ported** 25A – SYA 5 1 20 – C6

**Base mounted** 25A – SYA 5 1 40 – [ ]

**Series compatible with secondary batteries**

**Series**

5	SYA5000
7	SYA7000

**Series**

5	SYA5000
7	SYA7000

**Type of actuation**

1	2-position single
2	2-position double
3	3-position closed center
4	3-position exhaust center
5	3-position pressure center

**A, B port size Thread piping**

Symbol	Port size	Applicable series
01	1/8	SYA5000
02	1/4	SYA7000

**One-touch fitting (Metric size)**

Symbol	Port size	Applicable series
C4	ø4 One-touch fitting	SYA5000
C6	ø6 One-touch fitting	
C8	ø8 One-touch fitting	
C8	ø8 One-touch fitting	SYA7000
C10	ø10 One-touch fitting	

**Port size**

Symbol	Port size	Applicable series
Nil	Without sub-plate	
02	1/4 With sub-plate	SYA5000
02	1/4 With sub-plate	SYA7000
03	3/8 With sub-plate	

## How to Order Manifold Base

Same manifolds as the SY series (Non plug-in type) are prepared.  
(For 20, 41 and 42 Types)

25A-SS5YA<sup>5</sup><sub>7</sub>- [ ] Fill the same as 25A-SS5Y<sup>5</sup><sub>7</sub>.

(Refer to page 40.)

\* Specify the part numbers for valves and options together beneath the manifold base part number.

<Example>

25A-SS5YA5-42-03-02....1 set (Type 42, 3 station manifold base part no.)

\* 25A-SYA5140 ..... 1 set (Single air operated valve part no.)

\* 25A-SYA5240 ..... 1 set (Double air operated valve part no.)

\* 25A-SY5000-26-1A ..... 1 set (Blanking plate assembly part no.)

↳The asterisk denotes the symbol for assembly.

Prefix it to the part nos. of the solenoid valve, etc.

\* When single body ported air operated valves are ordered, manifold mounting screws and gaskets are not included. Order them separately if necessary.  
(For details, refer to page 42.)

\* The 25A- series specifications and dimensions are the same as those of the standard model.

[Click here for details.](#)

# 3-Port Air Operated Valve

## 25A-SYJA500/700 Series

### How to Order

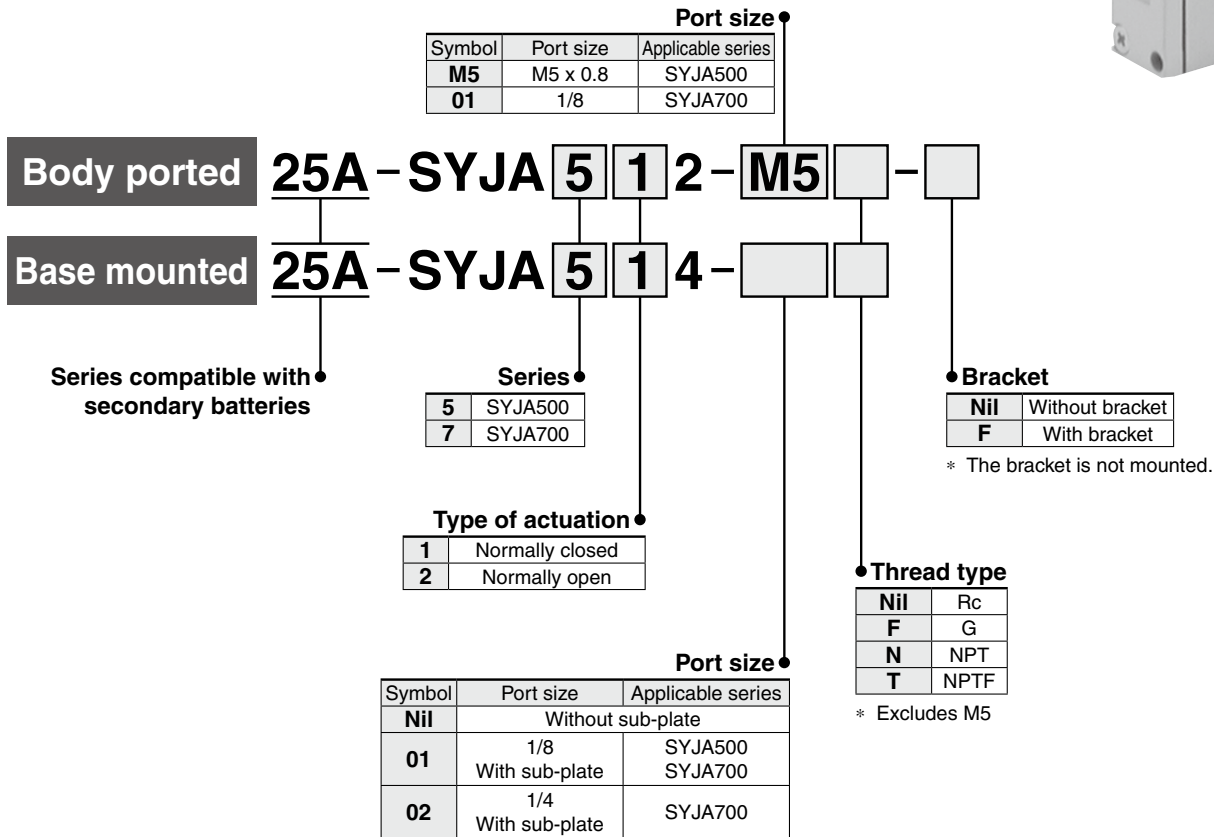

\* The 25A- series specifications and dimensions are the same as those of the standard model.

[Click here for details.](#)

Directional Control Valves

Air Cylinders

Related Products

Rotary Actuators

Air Grippers

Vacuum Equipment

Air Preparation Equipment

Clean Air Filters

Modular F.R.L./Pressure Control Equipment

Fittings/Flow Control Equipment

Detection Switches

Fluid Control Equipment

Electric Actuators

Auto Switches

# 25A-SYJA500/700 Series

## Manifold Type for the SYJA500

### Type 20

How to Order

25A - SS3YJA5 - 20 - 05

Stations

02	2 stations
:	:
20	20 stations

Applicable valve  
25A-SYJA5□2

Applicable blanking  
plate assembly  
25A-SYJ500-10-1A

\* For more than 6 stations, supply air to both sides of P port and exhaust air from both sides of R port.

### Type 40

How to Order

25A - SS3YJA5 - 40 - 05 M5

Stations

02	2 stations
:	:
20	20 stations

A port size

M5	M5 x 0.8
01	1/8

Applicable valve  
25A-SYJA5□4

Applicable blanking  
plate assembly  
25A-SYJ500-10-3A

\* For more than 9 stations, supply air to both sides of P port and exhaust air from both sides of R port.

### Type 41

How to Order

25A - SS3YJA5 - 41 - 05 - C6

Stations

02	2 stations
:	:
20	20 stations

A port size

M5	M5 x 0.8
01	1/8
C4	ø4 One-touch fitting
C6	ø6 One-touch fitting

Applicable valve  
25A-SYJA5□4

Applicable blanking  
plate assembly  
25A-SYJ500-10-3A

\* For more than 9 stations, supply air to both sides of P port and exhaust air from both sides of R port.

## Manifold Type for the SYJA700

### Type 20/21

How to Order

25A - SS3YJA7 - 20 - 05

Manifold type

20	Type 20
21	Type 21

Stations

02	2 stations
:	:
20	20 stations

Applicable valve  
25A-SYJA7□2

Applicable blanking  
plate assembly  
25A-SYJ700-10-1A

\* If there are more than 6 stations for type 20, or more than 9 stations for type 21, supply air to both sides of P port and exhaust air from both sides of R port.

### Type 40/41

How to Order

25A - SS3YJA7 - 40 - 05 - 01

Manifold type

40	Type 40
41	Type 41

A port size

01	1/8
----	-----

Stations

02	2 stations
:	:
20	20 stations

Applicable valve  
25A-SYJA7□4

Applicable blanking  
plate assembly  
25A-SYJ700-10-2A

\* If there are more than 6 stations for type 40, or more than 9 stations for type 41, supply air to both sides of P port and exhaust air from both sides of R port.

### Type 42

How to Order

25A - SS3YJA7 - 42 - 05 - C6

Stations

02	2 stations
:	:
20	20 stations

A port size

01	1/8
C6	ø6 One-touch fitting
C8	ø8 One-touch fitting

Applicable valve  
25A-SYJA7□4

Applicable blanking  
plate assembly  
25A-SYJ700-10-2A

\* For more than 9 stations, supply air to both sides of P port and exhaust air from both sides of R port.

# Finger Valve

# 25A-VHK Series



## How to Order

Series compatible with secondary batteries

25A-VHK 2 - 04F - 04F

Valve model

2	2-port valve
3	3-port valve

1(P) port size

04F	ø4
06F	ø6
08F	ø8
01S	R 1/8
02S	R 1/4
03S	R 3/8

Bracket

Nil	None
L	With L-bracket

\* Bracket and screws are attached.

Knob color

Nil (Standard)	2-port valve	Gray
	3-port valve	Blue
R (Option)	2-port valve	Red
	3-port valve	

2(A) port size

04F	ø4
06F	ø6
08F	ø8
01S	R 1/8
02S	R 1/4
03S	R 3/8

### Standard Type

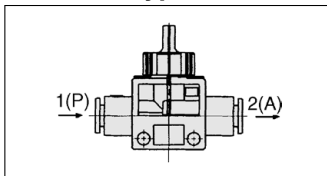

1(P): One-touch fitting  
2(A): One-touch fitting

		2(A)		
		Applicable tubing O.D. [mm]		
1(P)		ø4	ø6	ø8
		ø4	•	
Applicable tubing O.D. [mm]	ø6	•	•	
	ø8		•	•

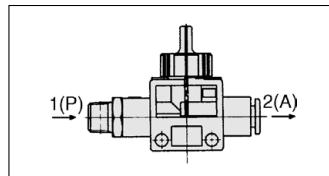

1(P): Male thread  
2(A): One-touch fitting

		2(A)		
		Applicable tubing O.D. [mm]		
1(P)		ø4	ø6	ø8
		1/8	•	•
Port size R	1/4		•	•
	3/8		•	•

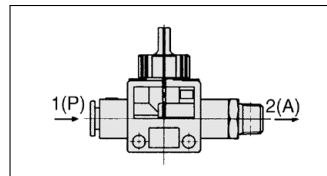

1(P): One-touch fitting  
2(A): Male thread

		2(A)		
		Port size R		
1(P)		1/8	1/4	3/8
		ø4	•	
Applicable tubing O.D. [mm]	ø6	•	•	•
	ø8	•	•	•

\* The 25A- series specifications and dimensions are the same as those of the standard model.

[Click here for details.](#)

# Conforming to OSHA Standard

## Pressure Relief 3-Port Valve with Locking Holes (Single Action)

# 25A-VHS20/30/40/50 Series

RoHS

### How to Order

**Single action** 25A - VHS 40 - [ ] 04 A - B - [ ] - [ ]

Series compatible with secondary batteries  
 Pressure relief 3-port valve

Body size

Symbol	Body size
20	20
30	30
40	40
50	50

Thread type

Symbol	Thread type
Nil	Rc
N	NPT
F	G

Port size

Symbol	Port size	Body size			
		20	30	40	50
01	1/8	●	—	—	—
02	1/4	●	●	●	—
03	3/8	—	●	●	—
04	1/2	—	—	●	—
06	3/4	—	—	●	●
10	1	—	—	—	●

Handle/Bonnet material

Symbol	Material
A	Flame-resistant PBT
B	Aluminum

Made to order

Symbol	Description
X1	Body: Red

Semi-standard specifications

Symbol	Description
Nil	—
K	Handle color: Black
R	Flow direction: Right → Left
Z*1	psi as unit displayed on label

\*1 Only for the NPT thread  
 This product is for overseas use only according to the New Measurement Act. (The SI unit type is provided for use in Japan.)

Options

Symbol	Description
Nil	—
B	With bracket

### Option Part Nos.

Model	Bracket assembly part no.*1
25A-VHS20	VHS20PW-180AS-6
25A-VHS30	VHS30PW-180AS-6
25A-VHS40	VHS40PW-180AS-6
25A-VHS40-06	VHS40PW-180-06AS-6
25A-VHS50	VHS50PW-180AS-6

\*1 Bracket/1 pc., Mounting screw/2 pcs.

### OSHA standard (Occupational Safety and Health Administration Department of Labor)

For safety control, OSHA rule requires energy sources for certain equipment be turned off or disconnected and that the device either be locked or labelled with a warning tag.

\* The 25A- series specifications and dimensions are the same as those of the standard model.

[Click here for details.](#)

# Conforming to OSHA Standard

## Pressure Relief 3-Port Valve with Locking Holes (Double Action)

# 25A-VHS2510/3510/4510/5510 Series

RoHS

### How to Order

**Double action** 25A - VHS 4 510 - [ ] 04 A - B - [ ] - [ ]

Series compatible with secondary batteries  
Pressure relief 3-port valve

Body size

Symbol
2
3
4
5

Double action

Thread type

Nil	Rc
N	NPT
F	G

Port size

Symbol	Port size	Body size			
		2	3	4	5
01	1/8	●	—	—	—
02	1/4	●	●	●	—
03	3/8	—	●	●	—
04	1/2	—	—	●	—
06	3/4	—	—	●	●
10	1	—	—	—	●

Handle/Bonnet material

Symbol	Material
A	Flame-resistant PBT
B	Aluminum

Made to order

Symbol	Description
X1	Body: Red

Semi-standard specifications

Symbol	Description
Nil	—
K	Handle color: Black
R	Flow direction: Right → Left
Z*1	psi as unit displayed on label

\*1 Only for the NPT thread  
This product is for overseas use only according to the New Measurement Act. (The SI unit type is provided for use in Japan.)

Options

Symbol	Description
Nil	—
B	With bracket

### Option Part Nos.

Model	Bracket assembly part no.*1
25A-VHS2510	VHS20PW-180AS-6
25A-VHS3510	VHS30PW-180AS-6
25A-VHS4510	VHS40PW-180AS-6
25A-VHS4510-06	VHS40PW-180-06AS-6
25A-VHS5510	VHS50PW-180AS-6

\*1 Bracket/1 pc., Mounting screw/2 pcs.

#### OSHA standard (Occupational Safety and Health Administration Department of Labor)

For safety control, OSHA rule requires energy sources for certain equipment be turned off or disconnected and that the device either be locked or labelled with a warning tag.

\* The 25A- series specifications and dimensions are the same as those of the standard model.

[Click here for details.](#)